

APPENDIX F
Access Management Study –
Driveway Turning Movement Counts

EXXON GAS STATION

64(94){106}<194>

60(80){125}<194>

BROADVIEW AVE NB DRIVEWAYS
(US 211, 17/29 BUS.)

0(0){0}<11>

0(0){0}<28>

2(10){2}<0>

63(23){8}<81>

0(0){0}<0>[3] CARE RX

0(0){0}<0>[23] ①

0(0){0}<0> ②

88(43){31}<97>

UPS DUNKIN DONUTS

McCLANAHAN CAMERA

ROEBLING ST

OLD BROADVIEW AVE

CHESWICK MOTEL / PUB

0(1){1}<0>

3(0){1}<10>

1(1){4}<2>

0(0){0}<0>

BROADVIEW AVE SB DRIVEWAYS
(US 211, 17/29 BUS.)

2(0){0}<0>

7(5){3}<17>

0(1){3}<0>

2(3){0}<2>

72(57){55}<95>

72(85){50}<186>

22(5){4}<17>

3(0){1}<1> ①

71(71){57}<130>

24(28){36}<59> ②

1(0){1}<0>

0(0){0}<0> ③

McDONALDS

McDONALDS

RED HOT & BLUE

① 0(1){0}<0>

2(4){6}<4>

② 1(7){4}<11>

0(8){13}<19>

3(13){14}<17>

2(0){1}<1>

0(0){1}<1>

0(3){5}<13>

BROADVIEW AVE NB DRIVEWAYS
(US 211, 17/29 BUS.)

6(1){0}<2>

3(2){0}<0>

4(6){2}<3>

4(6){1}<3>

6(9){8}<5>

0(1){1}<2> ①

0(3){2}<1>

2(4){0}<1> ②

WILSON AUTOMOTIVE

WILSON AUTOMOTIVE

TEXACO GAS STATION

① 4(7){7}<10>

1(6){3}<15>

② 6(5){1}<8>

6(25){23}<30>

13(2){5}<27>

6(1){3}<14>

2(2){0}<2>

2(2){1}<13>

BROADVIEW AVE NB DRIVEWAYS
(US 211, 17/29 BUS.)

3(0){1}<3>

0(0){0}<0>

1(4){4}<22>

0(1){3}<10>

1(4){5}<5>

0(0){0}<2> ①

9(19){21}<43>

2(5){2}<4> ②

SHELL / DR. CAR WASH

SHELL / DR. CAR WASH

PIEMONT MOTORS

① 0(2){0}<3>

1(2){3}<3>

② 1(3){2}<10>

4(4){9}<26>

1(2){5}<15>

3(1){3}<9>

1(1){0}<3>

1(2){1}<5>

BROADVIEW AVE SB DRIVEWAYS
(US 211, 17/29 BUS.)

5(15){8}<16>

6(10){14}<32>

3(5){2}<2>

3(10){2}<1>

5(10){6}<14>

2(7){5}<9> ③

0(6){4}<0>

0(3){0}<0>

TRUSTED AUTOCARE

TRUSTED AUTOCARE

MATRESS WAREHOUSE

5(26){12}<27>

5(7){10}<27>

6(13){12}<7>

6(17){11}<15>

BROADVIEW AVE NB DRIVEWAYS
(US 211, 17/29 BUS.)

0(0){0}<0>

0(0){0}<0>

1(73){38}<97>

0(22){17}<38> ①

WENDYS

WENDYS

JIFFY LUBE

3(6){5}<16>

1(7){7}<36>

2(8){11}<35>

5(7){1}<10>

BROADVIEW AVE SB DRIVEWAYS
(US 211, 17/29 BUS.)

0(39){24}<83>

0(48){24}<89>

0(0){0}<0>

0(0){0}<1> ②

CHAPPELL ST

CHAPPELL ST

WARRENTON PLAZA

① 0(4){9}<8>

1(3){0}<6>

② 1(2){2}<6>

2(5){2}<7>

③ 4(9){9}<12>

3(14){17}<23>

0(7){4}<7>

0(2){0}<0>

4(2){0}<2>

6(1){0}<0>

4(4){4}<8>

1(12){8}<19>

BROADVIEW AVE NB DRIVEWAYS
(US 211, 17/29 BUS.)

0(0){0}<0>

1(3){1}<0>

6(8){1}<0>

6(2){1}<1>

9(6){3}<10>

3(0){1}<13>

0(5){2}<1>

1(4){1}<0> ①

1(0){1}<1>

0(3){1}<0> ②

4(5){5}<8>

2(2){3}<12>

MIDAS

REXEL LK FOLEY

MIDAS

VACANT LOT

0(0){0}<0>

0(0){1}<3>

0(0){0}<2>

0(2){1}<2>

BROADVIEW AVE SB DRIVEWAYS
(US 211, 17/29 BUS.)

0(0){0}<1>

0(0){2}<2>

0(3){4}<2>

0(1){0}<0> ①

MOSER FUNERAL HOME

MOSER FUNERAL HOME

TACO BELL

4(17){22}<62>

11(66){49}<105>

10(57){35}<100>

3(34){36}<58>

BROADVIEW AVE NB DRIVEWAYS
(US 211, 17/29 BUS.)

4(2){2}<2>

1(4){0}<3>

0(8){0}<22>

0(3){0}<2> ②

MOSER FUNERAL HOME

MATCHLINE SHEET 1

GOLD CUP DR	UNION BANK	① 0(0){0}<2> 0(0){1}<0>	↖ 7(20){12}<18> ↗ 1(13){7}<12>	BROADVIEW AVE SB DRIVEWAYS (US 211, 17/29 BUS.)	BROADVIEW AVE NB DRIVEWAYS (US 211, 17/29 BUS.)	0(0){0}<4>	↖ 1(3){1}<3> ↗ 1(0){0}<2>	CASH POINT	
		② 2(14){2}<17> 2(15){15}<14>	↖ 0(21){0}<1> ↗ 0(1){0}<0>			3(1){2}<4>	↖ 2(1){1}<0> ↗ 1(2){0}<0>		RF KUBE HORIZON
	KFC	0(6){18}<39> 0(24){24}<25>	↖ 0(17){30}<48> ↗ 1(2){7}<21>			0(0){0}<1> 4(2){2}<1>	↖ 0(1){0}<0> ↗ 0(0){0}<0>		
RIP VAN WINKLE MOTEL	0(3){1}<4> 3(1){3}<2>	↖ 0(4){4}<6> ↗ 1(0){0}<0>	1(0){0}<1> 2(1){1}<0>						
GOLD CUP DR	CECILS	3(0){0}<1> 3(6){5}<6>	↖ 1(1){0}<8> ↗ 3(3){3}<4>	BROADVIEW AVE SB DRIVEWAYS (US 211, 17/29 BUS.)	BROADVIEW AVE NB DRIVEWAYS (US 211, 17/29 BUS.)	0(0){1}<1>	↖ 0(2){2}<0> ↗ 0(0){0}<0>	HOUSE	
		① 3(3){3}<6> 1(3){0}<10>	↖ 5(8){13}<21> ↗ 0(2){7}<9>			0(1){2}<0>	↖ 0(68){47}<136> ↗ 0(27){14}<42>		WELLS FARGO BANK
	MATRRESS WAREHOUSE/ TRACTOR, INC./KARATE SPORT ACADEMY/SHERMAN WILLIAMS	0(5){3}<11> 4(8){15}<29>	↖ 0(1){2}<4> ↗ 5(0){3}<13>			0(2){18}<22>	↖ 0(1){5}<7> ↗ 0(3){3}<12>		
		② 0(3){3}<4> 0(0){0}<4>	↖ 2(8){0}<2> ↗ 1(6){1}<4>			0(64){34}<149> 0(39){21}<48>	↖ 24(49){29}<70> ↗ 14(9){7}<20>		HOUSE
	OAK VIEW BANK	2(10){3}<3> 1(15){7}<15>	↖ 2(7){3}<0> ↗ 7(10){2}<10>			9(8){7}<9> 23(10){22}<40>	↖ 30(8){9}<23> ↗ 9(6){18}<26>		
		① 0(1){1}<0> 1(4){2}<5>	↖ 1(6){3}<11> ↗ 1(2){1}<12>			12(49){24}<73> 16(18){6}<22>	↖ 0(0){0}<1> ↗ 0(0){0}<0>		SHELL GAS STATION
	JEFFERSON MOTEL/ SUBWAY	0(8){7}<21> 5(28){8}<39>	↖ 1(15){6}<13> ↗ 2(12){5}<16>			0(0){0}<0> 0(3){0}<0>	↖ 1(13){0}<17> ↗ 1(2){0}<1>		
		② 0(2){0}<2> 1(6){0}<8>	↖ 1(10){8}<7> ↗ 1(10){3}<5>			1(5){1}<1> 1(5){1}<17>	↖ 13(34){12}<52> ↗ 5(10){9}<18>		WELLS AUTO SALES
	JEFFERSON MOTEL / EL TORO RESTAURANT	3(5){5}<8> 2(8){3}<10>	↖ 0(0){0}<0> ↗ 0(0){0}<0>			8(12){15}<20> 29(46){42}<100>	↖ 1(1){0}<10> ↗ 2(2){0}<3>		
		① 1(5){3}<3> 1(4){7}<0>	↖ 12(8){6}<5> ↗ 2(6){2}<4>			5(18){8}<11> 6(0){0}<2> 10(6){0}<14>	↖ 1(2){6}<18> ↗ 0(0){1}<2>		JD HANDYMAN
	JK AUTO PARTS / WELLS AUTO	6(12){3}<11> 7(19){17}<9>	↖ 6(7){8}<1> ↗ 5(13){7}<11>			2(1){0}<0> 1(0){1}<1> 2(0){0}<0>	↖ 3(3){0}<2> ↗ 1(0){0}<0>		
		② 0(4){0}<6> 0(5){0}<3>	↖ 26(67){37}<121> ↗ 22(40){19}<60>			5(13){6}<14> 1(1){4}<6>	↖ 1(7){14}<26> ↗ 0(2){3}<3>		
BURGER KING	14(25){10}<91> 23(86){42}<131>	↖ 0(2){0}<3> ↗ 4(4){1}<6>	0(3){2}<5> 2(3){2}<3>	↖ 1(4){3}<2> ↗ 0(0){0}<0>					
	① 0(4){0}<6> 0(5){0}<3>	↖ 7(13){11}<12> ↗ 4(6){6}<9>	2(0){0}<0> 2(1){0}<1>	↖ 0(3){0}<1> ↗ 0(0){0}<0>					
HOWARD JOHNSON HOTEL/ FOSTORS GRILLE	12(8){11}<24> 8(13){6}<27>	↖ 7(13){11}<12> ↗ 4(6){6}<9>	0(0){0}<0> 0(3){0}<0>	↖ 0(2){1}<5> ↗ 0(0){0}<0>					

FROST AVE (US 211)

WATERLOO ST (US 211 BUS.)

DRIVEWAY VOLUMES: 7-9AM(11-1PM){4-6PM}<SAT 11-3PM>

APPENDIX G
Traffic Studies –
Intersection Turning Movement Counts

Request No.:
 Job No.:

Location: Broadview Avenue/ W. Shirley Avenue @ Frost Avenue/ Waterloo Street
 Date: 10/23/2014 Thursday
 Recorder: LCM DJM
 Interval (dd) : 15
 (In Minutes)

County: Fauquier, VA
 Town: Warrenton
 Weather: Clear, Cool

PEAK HOURS	AM PERIOD 6:00AM-12:00PM	Start	End	Volume	PM PERIOD 12:00PM-7:00PM	Start	End	Volume
		07:00	08:00	2623		16:45	17:45	3712

PEDESTRIAN SCHOOL CHILDREN & U-TURN BREAKDOWN

Hour Ending	Broadview Avenue			W. Shirley Avenue			Waterloo Street			Frost Avenue		
	BIKES	PED.	U.T.	BIKES	PED.	U.T.	BIKES	PED.	U.T.	BIKES	PED.	U.T.
00:15												
00:30												
00:45												
01:00												
01:15												
01:30												
01:45												
02:00												
02:15												
02:30												
02:45												
03:00												
03:15												
03:30												
03:45												
04:00												
04:15												
04:30												
04:45												
05:00												
05:15												
05:30												
05:45												
06:00												
06:15	0	0	0	0	0	0	0	1	0	0	0	0
06:30	0	0	0	0	0	0	0	0	0	0	0	1
06:45	0	0	0	0	0	0	0	0	0	0	0	0
07:00	0	0	0	0	0	0	0	0	0	0	0	0
07:15	0	0	1	0	0	0	0	0	0	0	0	0
07:30	0	0	0	0	1	0	0	0	0	0	0	0
07:45	0	0	0	0	0	1	0	0	0	0	0	1
08:00	0	0	0	0	0	0	0	0	0	0	0	0
08:15	0	0	0	0	0	0	0	0	0	0	0	1
08:30	0	0	0	0	0	0	0	0	0	0	1	0
08:45	0	0	0	0	0	0	0	0	0	0	0	0
09:00	0	1	0	0	0	0	0	0	0	0	0	0
09:15	0	0	0	0	0	0	0	0	0	0	0	0
09:30	0	0	0	0	0	0	0	0	0	0	0	0
09:45	0	1	0	0	0	0	0	0	0	0	0	0
10:00	0	0	0	0	2	0	0	0	0	0	0	0
10:15	0	1	0	0	0	0	0	0	0	0	0	0
10:30	0	0	0	0	0	0	0	0	0	0	0	0
10:45	0	0	0	0	0	0	0	0	0	0	0	0
11:00	0	0	0	0	0	0	0	0	0	0	0	1
11:15	0	1	0	0	0	0	0	2	0	0	0	3
11:30	0	1	0	0	0	0	0	0	0	0	1	2
11:45	0	0	0	0	0	0	0	0	0	0	0	1
12:00	0	0	1	0	0	0	0	0	0	0	1	1
12:15	0	0	0	0	0	0	1	0	0	0	1	1
12:30	1	0	0	0	0	0	0	0	0	0	0	2
12:45	0	0	0	0	0	0	0	0	0	0	0	1
13:00	0	0	0	0	0	0	0	0	0	0	0	0
13:15	0	0	0	0	0	0	0	0	0	0	0	0
13:30	0	0	0	0	0	0	0	0	0	0	0	2
13:45	0	0	0	0	1	0	0	0	0	0	0	1
14:00	0	2	0	0	0	0	0	0	0	0	0	0
14:15	0	0	0	0	0	0	0	0	0	0	0	0
14:30	0	1	0	0	0	0	0	0	0	0	0	0
14:45	0	0	0	0	0	0	0	0	0	0	0	3
15:00	0	2	0	0	0	0	0	4	0	0	2	0
15:15	0	0	0	0	1	0	0	0	0	0	8	0
15:30	0	0	0	0	7	0	0	0	0	0	5	0
15:45	0	1	0	0	0	1	0	0	0	1	0	0
16:00	0	1	0	0	0	0	0	0	0	0	0	0
16:15	0	1	0	0	0	0	0	0	0	0	0	1
16:30	0	0	0	0	0	0	0	3	0	0	0	0
16:45	0	0	0	0	0	0	0	1	0	0	1	0
17:00	0	1	0	0	0	0	0	2	0	0	0	0
17:15	0	1	0	0	0	0	0	0	0	0	0	0
17:30	0	1	0	0	0	0	0	2	0	0	0	0
17:45	0	0	0	0	0	0	0	0	0	0	0	1
18:00	0	1	0	0	0	0	0	0	0	0	0	0
18:15	0	1	0	0	0	0	0	0	0	0	0	0
18:30	0	0	1	0	0	0	0	0	0	0	0	0
18:45	0	0	0	0	0	0	0	0	0	0	0	1
19:00	0	0	1	0	0	0	0	0	0	0	0	0
19:15												
19:30												
19:45												
20:00												
20:15												
20:30												
20:45												
21:00												
21:15												
21:30												
21:45												
22:00												
22:15												
22:30												
22:45												
23:00												
23:15												
23:30												
23:45												
00:00												
TOTAL	1	18	4	0	12	3	0	15	1	0	20	23
AM Peak Vol	0	0	1	0	1	1	0	0	0	0	0	1
PM Peak Vol	0	3	0	0	0	0	0	4	0	0	0	1

Request No.:
 Job No.:

Location: Broadview Avenue/ W. Shirley Avenue @ Frost Avenue/ Waterloo Street
 Date: 10/23/2014 Thursday
 Recorder: LCM DJM
 Interval (dd): 15
 (In Minutes)

County: Fauquier, VA
 Town: Warrenton
 Weather: Clear, Cool

PEAK HOURS	AM PERIOD	Start	End	Volume	PM PERIOD	Start	End	Volume
	6:00AM-12:00PM	07:00	08:00	2623	12:00PM-7:00PM	16:45	17:45	3712

Turning Movement Summary:

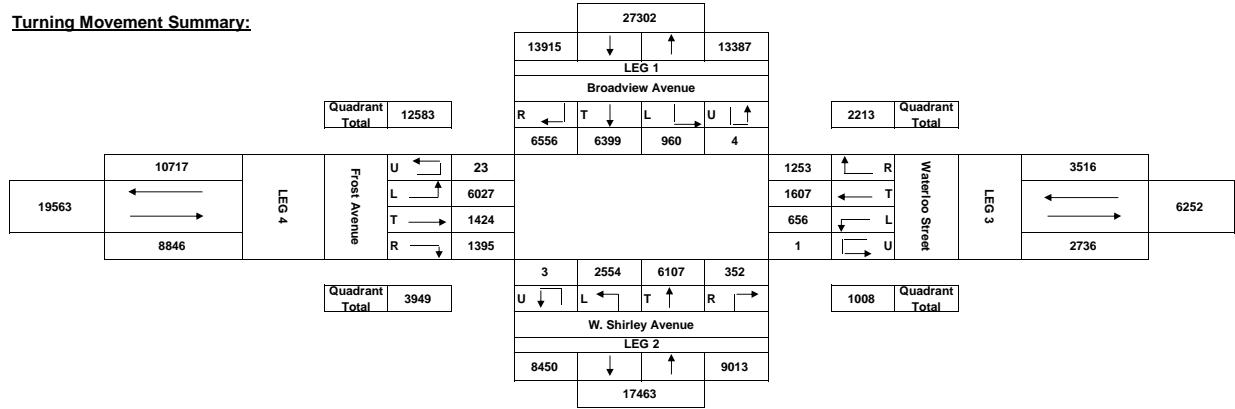

Comments:

AM Peak Hour: X:XX A.M. - X:XX A.M.

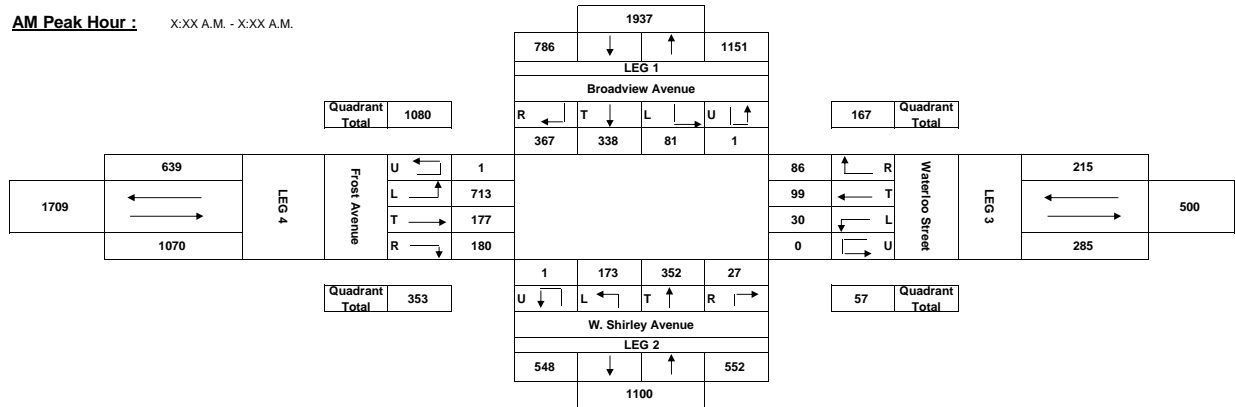

PM Peak Hour: X:XX P.M. - X:XX P.M.

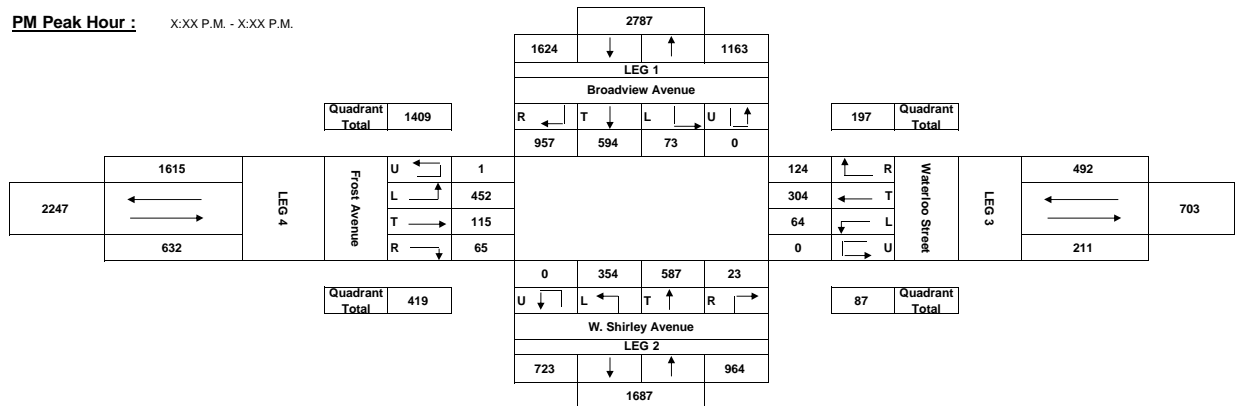

Request No.:
Job No.:

Location: Broadview Avenue @ Church Street
Date: 10/23/2014 Thursday
Recorder: LCM DJM
Interval (dd) : 15
(In Minutes)

County: Fauquier, VA
Town: Warrenton
Weather: Clear, Cool

PEAK HOURS	AM PERIOD 6:00AM-12:00PM	Start	End	Volume	PM PERIOD 12:00PM-7:00PM	Start	End	Volume
		10:45	11:45	2042		16:45	17:45	2709

Hour Ending	Broadview Avenue			Broadview Avenue			Church Street			0		
	BIKES	PED.	U.T.	BIKES	PED.	U.T.	BIKES	PED.	U.T.	BIKES	PED.	U.T.
00:15												
00:30												
00:45												
01:00												
01:15												
01:30												
01:45												
02:00												
02:15												
02:30												
02:45												
03:00												
03:15												
03:30												
03:45												
04:00												
04:15												
04:30												
04:45												
05:00												
05:15												
05:30												
05:45												
06:00												
06:15	0	0	0	0	1	0	0	2	0	0	0	0
06:30	0	1	0	0	0	0	0	0	1	0	0	0
06:45	0	3	0	0	0	0	0	0	3	0	0	0
07:00	0	0	0	0	0	0	0	0	0	0	0	0
07:15	0	0	0	0	0	0	0	0	0	0	0	0
07:30	0	1	0	0	1	0	0	0	1	0	0	0
07:45	0	0	0	0	0	0	0	0	0	0	0	0
08:00	0	2	0	0	0	0	0	0	0	0	1	0
08:15	0	0	0	0	0	0	0	0	0	0	0	0
08:30	0	1	0	0	0	0	0	0	0	0	0	0
08:45	0	0	0	0	0	0	0	0	0	0	1	0
09:00	0	0	0	0	0	0	0	0	1	0	0	0
09:15	0	0	0	0	0	0	0	0	0	0	0	0
09:30	0	0	0	0	0	0	0	0	0	0	0	0
09:45	0	0	0	0	0	0	0	0	0	0	0	0
10:00	0	0	0	0	2	0	0	0	0	0	1	0
10:15	0	0	0	0	1	0	0	0	2	0	0	0
10:30	0	0	0	0	0	0	0	0	0	0	0	0
10:45	0	0	0	0	1	0	0	0	0	0	0	0
11:00	0	0	0	0	0	0	0	0	2	0	0	0
11:15	0	0	0	0	0	0	0	0	0	0	1	0
11:30	0	0	0	0	0	0	0	0	1	0	0	0
11:45	0	1	0	0	0	0	0	0	0	0	1	0
12:00	0	1	1	0	1	0	0	0	1	0	0	0
12:15	0	0	0	0	0	0	0	0	0	0	0	0
12:30	0	0	0	1	0	0	0	0	0	0	0	0
12:45	0	0	0	0	1	0	0	0	0	0	0	0
13:00	0	0	0	0	0	0	0	0	1	0	0	0
13:15	0	0	0	0	0	0	0	0	0	0	0	0
13:30	0	0	0	0	0	0	0	0	1	0	0	0
13:45	0	1	0	0	0	0	0	0	0	0	1	0
14:00	0	0	0	0	0	0	0	0	0	0	1	0
14:15	0	0	0	0	0	0	0	0	0	0	0	0
14:30	0	0	1	0	0	0	1	0	0	0	2	0
14:45	0	0	0	0	0	0	0	0	0	0	2	0
15:00	0	0	0	0	0	0	0	0	2	0	0	0
15:15	0	0	0	0	0	0	0	0	0	0	1	0
15:30	0	0	0	0	0	0	0	0	0	0	0	0
15:45	0	0	0	0	0	0	0	0	1	0	0	0
16:00	0	0	1	0	0	0	0	0	2	0	0	0
16:15	0	0	0	0	0	0	0	0	1	0	4	0
16:30	0	0	0	0	0	0	0	0	1	0	0	0
16:45	0	0	1	0	0	0	0	0	0	0	0	0
17:00	0	0	0	0	2	0	0	0	0	0	0	0
17:15	0	0	0	0	0	0	0	0	0	0	0	0
17:30	0	1	0	0	0	0	0	0	0	0	0	0
17:45	0	0	0	0	0	0	0	0	0	0	0	0
18:00	0	1	0	0	0	0	0	0	3	0	0	0
18:15	0	0	0	0	0	0	0	0	1	0	0	0
18:30	0	0	0	0	0	0	0	0	0	0	0	0
18:45	0	0	0	0	0	0	0	0	0	0	0	0
19:00	0	0	0	0	1	0	0	0	1	0	0	0
19:15												
19:30												
19:45												
20:00												
20:15												
20:30												
20:45												
21:00												
21:15												
21:30												
21:45												
22:00												
22:15												
22:30												
22:45												
23:00												
23:15												
23:30												
23:45												
00:00												
TOTAL	0	13	4	1	11	0	0	28	0	0	20	0
AM Peak Vol	0	1	0	0	0	0	0	3	0	0	2	0
PM Peak Vol	0	1	0	0	2	0	0	0	0	0	0	0

Request No.:
 Job No.:

Location: Broadview Avenue @ Church Street
 Date: 10/23/2014 Thursday
 Recorder: LCM DJM
 Interval (dd): 15
 (In Minutes)

County: Fauquier, VA
 Town: Warrenton
 Weather: Clear, Cool

PEAK HOURS	AM PERIOD	Start	End	Volume	PM PERIOD	Start	End	Volume
	6:00AM-12:00PM	10:45	11:45	2042	12:00PM-7:00PM	16:45	17:45	2709

Turning Movement Summary:

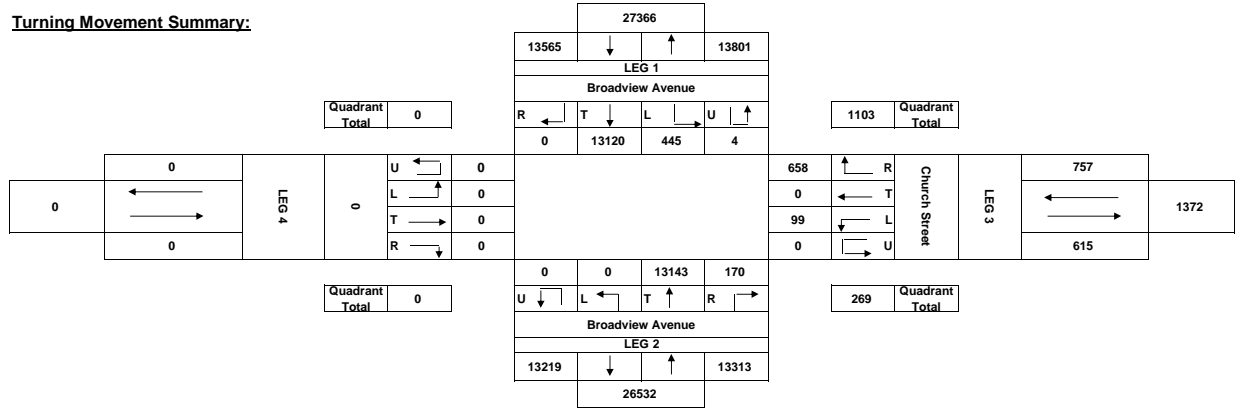

Comments:

AM Peak Hour : X:XX A.M. - X:XX A.M.

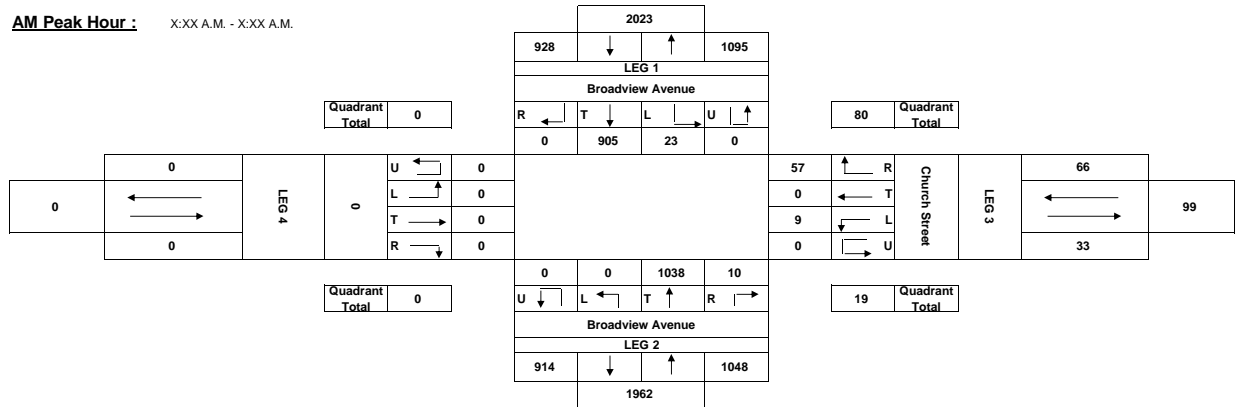

PM Peak Hour : X:XX P.M. - X:XX P.M.

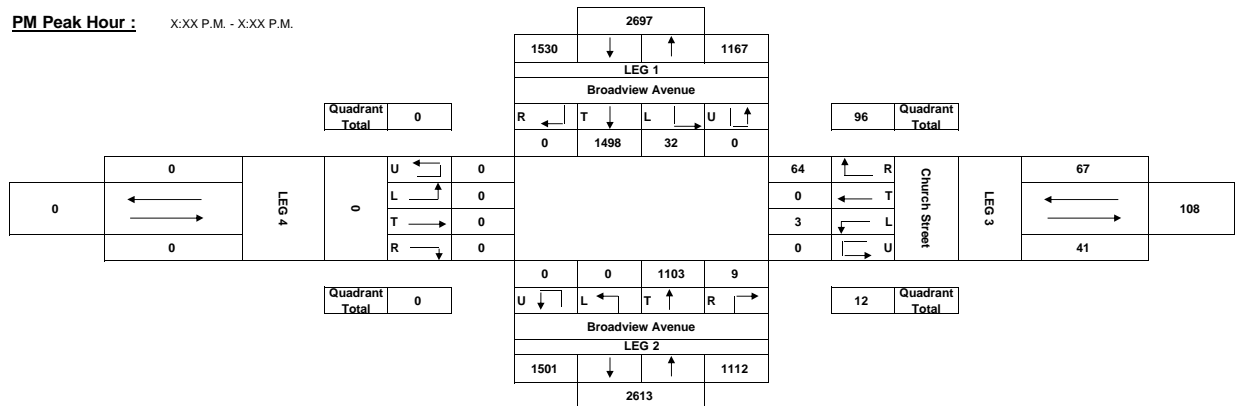

Request No.:
 Job No.:

Location: Broadview Avenue @ Stuyvesant Street/ Gold Cup Drive
 Date: 10/23/2014 Thursday
 Recorder: BDD
 Interval (dd): 15
 (In Minutes)

County: Fauquier, VA
 Town: Warrenton
 Weather: Clear, Cool

PEAK HOURS	AM PERIOD 6:00AM-12:00PM	Start 10:45	End 11:45	Volume 2237	PM PERIOD 12:00PM-7:00PM	Start 16:45	End 17:45	Volume 3425
------------	--------------------------	-------------	-----------	-------------	--------------------------	-------------	-----------	-------------

Street Name-->	Broadview Avenue			Broadview Avenue			Stuyvesant Street			Gold Cup Drive			GRAND TOTAL
	From North			From South			From East			From West			
Hour Ending	L	T	R	TOT	L	T	R	TOT	L	T	R	TOT	
00:15				0				0				0	0
00:30				0				0				0	0
00:45				0				0				0	0
01:00				0				0				0	0
01:15				0				0				0	0
01:30				0				0				0	0
01:45				0				0				0	0
02:00				0				0				0	0
02:15				0				0				0	0
02:30				0				0				0	0
02:45				0				0				0	0
03:00				0				0				0	0
03:15				0				0				0	0
03:30				0				0				0	0
03:45				0				0				0	0
04:00				0				0				0	0
04:15				0				0				0	0
04:30				0				0				0	0
04:45				0				0				0	0
05:00				0				0				0	0
05:15				0				0				0	0
05:30				0				0				0	0
05:45				0				0				0	0
06:00				0				0				0	0
06:15	0	46	0	46	1	193	0	194	2	0	1	3	246
06:30	0	68	3	71	1	250	0	251	0	0	1	1	328
06:45	0	102	1	103	0	195	0	195	0	0	0	13	315
07:00	0	171	1	172	3	224	2	229	2	0	2	4	417
07:15	0	240	3	243	2	258	1	261	4	0	0	6	519
07:30	1	207	4	212	7	323	3	333	0	0	1	13	572
07:45	2	177	5	184	3	298	3	304	2	0	1	3	499
08:00	5	183	1	189	1	308	11	320	1	0	1	2	517
08:15	2	222	4	228	1	274	3	278	2	0	5	7	620
08:30	4	218	2	224	5	244	5	254	4	0	0	4	495
08:45	6	230	5	241	2	283	14	299	1	0	2	3	552
09:00	3	223	6	232	1	229	5	235	3	0	7	10	486
09:15	0	223	5	228	2	257	4	263	3	0	2	5	503
09:30	0	215	2	217	2	269	7	278	4	0	2	6	511
09:45	1	193	4	198	1	248	4	253	3	0	2	5	465
10:00	9	175	2	186	2	268	8	278	1	0	3	4	475
10:15	2	198	2	202	3	226	2	231	3	0	4	7	442
10:30	1	237	5	243	2	260	5	267	2	0	3	5	522
10:45	2	251	4	257	4	261	2	267	4	0	8	12	604
11:00	4	249	4	257	8	293	5	306	4	0	3	7	653
11:15	0	179	4	183	4	249	0	253	4	0	5	9	579
11:30	1	259	4	264	3	284	9	296	2	0	3	5	453
11:45	5	264	3	272	5	327	3	335	4	0	10	14	574
12:00	1	196	8	205	6	259	3	268	6	0	9	15	631
12:15	3	285	6	294	7	371	4	382	1	0	3	4	493
12:30	7	293	10	310	3	313	1	317	2	0	7	9	688
12:45	3	323	6	332	3	329	8	340	4	0	2	6	649
13:00	4	268	10	282	3	296	4	303	6	0	3	8	688
13:15	6	321	7	334	2	278	4	284	4	0	0	9	604
13:30	2	268	9	279	3	319	1	323	2	0	4	6	634
13:45	2	249	5	256	6	240	4	250	4	0	0	6	623
14:00	1	251	6	258	1	244	4	249	1	0	1	2	523
14:15	0	263	10	273	5	296	4	305	0	0	6	6	515
14:30	3	292	5	300	4	279	3	286	8	0	2	10	591
14:45	2	271	8	281	8	287	3	298	3	0	5	8	616
15:00	1	290	8	299	4	349	7	360	5	0	1	6	602
15:15	1	351	10	362	4	369	8	381	6	0	1	6	675
15:30	3	403	8	414	6	374	7	387	2	0	5	7	762
15:45	6	427	11	444	5	362	4	371	7	0	5	12	815
16:00	3	420	9	432	7	332	10	349	5	0	5	10	838
16:15	1	448	11	460	7	314	4	325	3	0	6	9	805
16:30	2	474	7	483	7	317	4	328	2	0	3	5	814
16:45	2	390	8	400	3	340	1	344	8	0	4	12	809
17:00	2	455	9	466	8	398	1	407	8	0	1	9	830
17:15	4	561	21	586	8	285	3	296	4	1	2	7	766
17:30	1	467	18	486	8	344	4	356	2	0	7	9	888
17:45	2	417	13	432	3	335	3	341	0	0	3	3	900
18:00	5	389	7	401	0	316	7	323	5	1	1	7	858
18:15	2	405	12	419	4	266	0	270	3	0	1	4	737
18:30	2	388	15	405	4	275	1	280	0	0	2	2	698
18:45	1	387	12	400	5	251	2	258	10	0	6	16	699
19:00	3	397	11	411	4	280	1	285	2	0	3	5	686
19:15				0				0					716
19:30				0				0					0
19:45				0				0					0
20:00				0				0					0
20:15				0				0					0
20:30				0				0					0
20:45				0				0					0
21:00				0				0					0
21:15				0				0					0
21:30				0				0					0
21:45				0				0					0
22:00				0				0					0
22:15				0				0					0
22:30				0				0					0
22:45				0				0					0
23:00				0				0					0
23:15				0				0					0
23:30				0				0					0
23:45				0				0					0
00:00				0				0					0

TOTAL	123	14879	354	15356	201	15039	206	15446	168	2	168	338	250	2	269	521	31661
AM Peak Vol	10	951	15	976	20	1153	17	1190	14	0	21	35	16	0	20	36	2237
PM Peak Vol	9	1900	61	1970	27	1362	11	1400	14	1	13	28	7	0	20	27	3425

Request No.:
 Job No.:

Location: Broadview Avenue @ Stuyvesant Street/ Gold Cup Drive
Date: 10/23/2014 Thursday
Recorder: BDD
Interval (dd) : 15
(In Minutes)

County: Fauquier, VA
Town: Warrenton
Weather: Clear, Cool

PEAK HOURS	AM PERIOD 6:00AM-12:00PM	Start	End	Volume	PM PERIOD 12:00PM-7:00PM	Start	End	Volume
		10:45	11:45	2237		16:45	17:45	3425

PEDESTRIAN SCHOOL CHILDREN & U-TURN BREAKDOWN

Hour Ending	Broadview Avenue			Broadview Avenue			Stuyvesant Street			Gold Cup Drive		
	BIKES	PED.	U.T.	BIKES	PED.	U.T.	BIKES	PED.	U.T.	BIKES	PED.	U.T.
00:15												
00:30												
00:45												
01:00												
01:15												
01:30												
01:45												
02:00												
02:15												
02:30												
02:45												
03:00												
03:15												
03:30												
03:45												
04:00												
04:15												
04:30												
04:45												
05:00												
05:15												
05:30												
05:45												
06:00												
06:15	0	0	0	0	0	0	0	0	0	0	0	0
06:30	0	0	0	0	0	0	0	0	0	0	0	0
06:45	0	0	0	0	0	0	0	0	0	0	0	0
07:00	0	0	0	0	0	0	0	0	0	0	0	0
07:15	0	0	0	0	0	0	0	0	0	0	0	0
07:30	0	0	0	0	0	0	0	0	0	0	0	0
07:45	0	0	0	0	0	0	0	0	0	0	0	0
08:00	0	0	0	0	0	0	0	0	0	0	1	0
08:15	0	0	0	0	0	0	0	0	0	0	0	0
08:30	0	0	0	0	0	0	0	0	0	0	0	0
08:45	0	0	0	0	1	0	0	0	0	0	1	0
09:00	0	0	1	0	0	0	0	0	0	0	0	0
09:15	0	0	0	0	0	0	0	1	0	0	0	0
09:30	0	0	0	0	0	0	0	0	0	0	0	0
09:45	0	1	0	0	0	0	0	0	0	0	0	0
10:00	0	0	0	0	0	0	0	0	0	0	0	0
10:15	0	0	0	0	0	0	0	0	0	0	0	0
10:30	0	0	0	0	0	0	0	0	0	0	0	0
10:45	0	0	0	0	0	0	0	0	0	0	1	0
11:00	0	0	0	0	0	0	0	1	0	0	0	0
11:15	0	0	1	0	0	0	0	0	0	0	2	0
11:30	0	0	0	0	0	0	0	0	0	0	1	0
11:45	0	0	0	0	0	0	0	0	0	0	0	0
12:00	0	0	0	0	0	0	0	0	0	0	0	0
12:15	0	0	0	0	0	0	0	1	0	0	2	0
12:30	0	0	0	0	0	0	0	1	0	0	0	0
12:45	0	0	0	0	0	0	0	1	0	0	4	0
13:00	0	0	1	0	2	1	0	1	0	0	0	0
13:15	0	0	0	0	0	1	0	0	0	0	2	0
13:30	0	0	0	0	0	0	0	0	0	0	0	0
13:45	0	0	0	0	0	0	0	0	0	0	1	0
14:00	0	0	0	0	0	0	0	0	0	0	0	0
14:15	0	0	0	0	0	0	0	1	0	0	0	0
14:30	0	0	0	0	3	0	0	1	0	0	5	0
14:45	0	0	0	0	0	0	0	0	0	0	2	0
15:00	0	0	0	0	0	0	0	0	0	0	2	0
15:15	0	0	0	0	0	0	0	1	0	0	2	0
15:30	0	0	0	0	0	0	0	1	0	0	1	0
15:45	0	0	1	0	0	0	0	0	0	0	0	0
16:00	0	0	1	0	0	0	0	1	0	0	2	0
16:15	0	1	0	0	1	0	0	2	0	0	3	0
16:30	0	0	0	0	0	0	0	0	0	0	0	0
16:45	0	0	0	0	0	0	0	0	0	0	2	0
17:00	0	0	0	0	1	0	0	0	0	0	2	0
17:15	0	0	0	0	0	0	0	0	0	0	1	0
17:30	0	0	0	0	0	0	0	1	0	0	1	0
17:45	0	0	0	0	0	0	0	0	0	0	0	0
18:00	0	0	0	0	0	0	0	1	0	0	0	0
18:15	0	0	0	0	0	0	0	1	0	0	1	0
18:30	0	0	0	0	0	0	0	0	0	0	1	0
18:45	0	0	0	0	0	0	0	0	0	0	2	0
19:00	0	0	0	0	0	0	0	0	0	0	0	0
19:15												
19:30												
19:45												
20:00												
20:15												
20:30												
20:45												
21:00												
21:15												
21:30												
21:45												
22:00												
22:15												
22:30												
22:45												
23:00												
23:15												
23:30												
23:45												
00:00												
TOTAL	0	2	5	0	8	2	0	16	0	0	42	0
AM Peak Vol	0	0	1	0	0	0	0	1	0	0	3	0
PM Peak Vol	0	0	0	0	1	0	0	1	0	0	4	0

Request No.:
 Job No.:

Location: Broadview Avenue @ Stuyvesant Street/ Gold Cup Drive
 Date: 10/23/2014 Thursday
 Recorder: BDD
 Interval (dd): 15
 (In Minutes)

County: Fauquier, VA
 Town: Warrenton
 Weather: Clear, Cool

PEAK HOURS	AM PERIOD	Start	End	Volume	PM PERIOD	Start	End	Volume
	6:00AM-12:00PM	10:45	11:45	2237	12:00PM-7:00PM	16:45	17:45	3425

Turning Movement Summary:

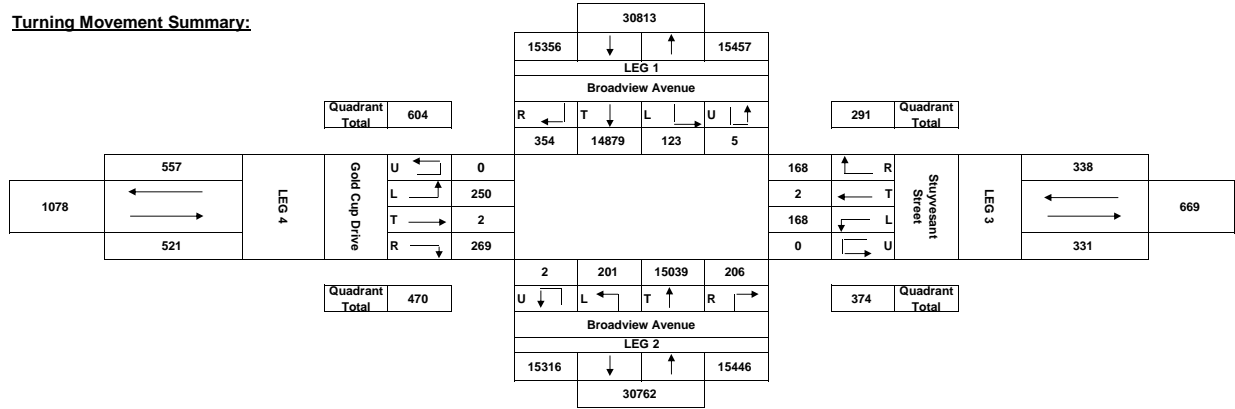

Comments:

AM Peak Hour : X:XX A.M. - X:XX A.M.

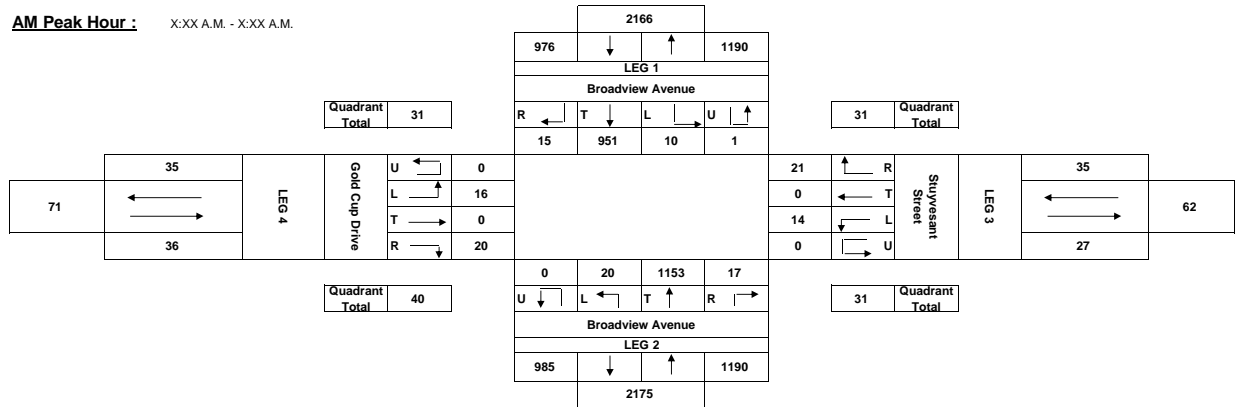

PM Peak Hour : X:XX P.M. - X:XX P.M.

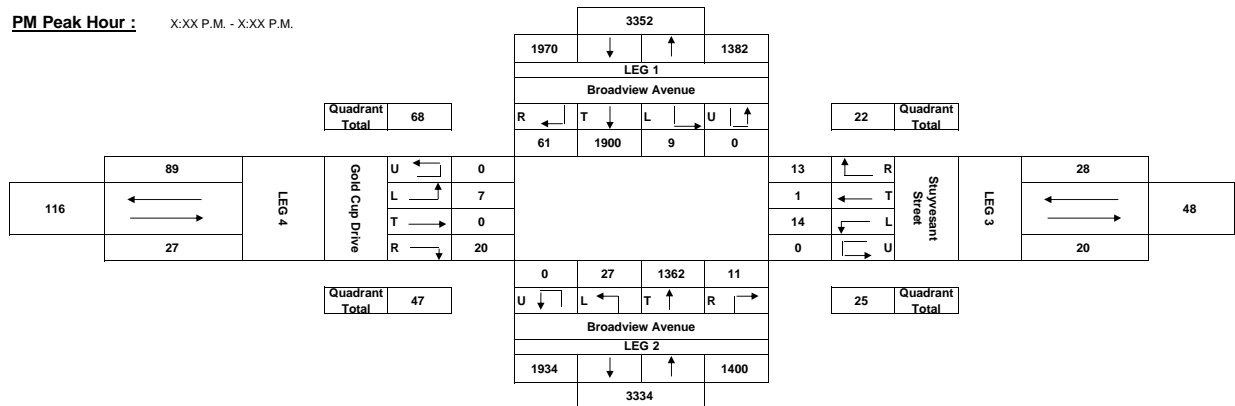

Request No.:
 Job No.:

Location: Broadview Avenue @ Chappell Street
 Date: 10/23/2014 Thursday
 Recorder: BDD
 Interval (dd) : 15
 (In Minutes)

County: Fauquier, VA
 Town: Warrenton
 Weather: Clear, Cool

PEAK HOURS	AM PERIOD 6:00AM-12:00PM	Start	End	Volume	PM PERIOD 12:00PM-7:00PM	Start	End	Volume
				11:00		12:00	2114	

PEDESTRIAN SCHOOL CHILDREN & U-TURN BREAKDOWN

Hour Ending	Broadview Avenue			Broadview Avenue			Chappell Street			0		
	BIKES	PED.	U.T.	BIKES	PED.	U.T.	BIKES	PED.	U.T.	BIKES	PED.	U.T.
00:15												
00:30												
00:45												
01:00												
01:15												
01:30												
01:45												
02:00												
02:15												
02:30												
02:45												
03:00												
03:15												
03:30												
03:45												
04:00												
04:15												
04:30												
04:45												
05:00												
05:15												
05:30												
05:45												
06:00												
06:15	0	0	0	0	0	0	0	0	0	0	0	0
06:30	0	0	0	0	0	0	0	0	0	0	0	0
06:45	0	0	0	0	0	0	0	0	0	0	0	0
07:00	0	0	0	0	0	0	0	0	0	0	0	0
07:15	0	0	0	0	0	1	0	1	0	0	0	0
07:30	0	0	0	0	0	0	0	0	0	0	0	0
07:45	0	0	0	0	0	0	0	0	0	0	0	0
08:00	0	0	0	0	0	0	0	1	0	0	0	0
08:15	0	1	0	0	0	1	0	2	0	0	0	0
08:30	0	0	0	0	0	0	0	1	0	0	0	0
08:45	0	0	0	0	0	0	0	0	0	0	0	0
09:00	0	0	0	0	0	0	0	2	0	0	0	0
09:15	0	0	0	0	0	1	0	0	0	0	1	0
09:30	0	0	0	0	0	0	0	0	0	0	0	0
09:45	0	0	0	0	0	0	0	0	0	0	0	0
10:00	0	0	0	0	0	0	0	0	0	0	0	0
10:15	0	0	0	0	0	0	0	2	0	0	0	0
10:30	0	0	0	0	0	0	0	0	0	0	1	0
10:45	0	0	0	0	0	1	0	3	0	0	0	0
11:00	0	0	0	0	0	0	0	0	0	0	1	0
11:15	0	0	0	0	0	0	0	2	0	0	0	0
11:30	0	0	0	0	2	0	0	2	0	0	0	0
11:45	0	0	0	0	0	0	0	0	0	0	0	0
12:00	0	0	0	0	0	0	0	0	0	0	1	0
12:15	0	0	0	0	0	1	0	2	0	0	0	0
12:30	0	0	0	0	0	0	0	1	0	0	0	0
12:45	0	0	0	0	0	1	0	0	0	0	0	0
13:00	0	0	0	0	0	0	0	2	0	0	1	0
13:15	0	0	0	0	0	0	0	0	0	0	0	0
13:30	0	0	0	0	0	0	0	1	0	0	0	0
13:45	0	0	0	0	0	0	0	0	0	0	1	0
14:00	0	0	0	0	0	0	0	2	0	0	0	0
14:15	0	0	0	0	0	0	0	2	0	0	2	0
14:30	0	0	0	0	0	0	0	3	0	0	1	0
14:45	0	0	0	1	0	1	0	0	0	1	0	0
15:00	0	0	0	0	0	0	0	1	0	0	0	0
15:15	0	0	0	0	0	0	0	4	0	0	0	0
15:30	0	0	0	0	0	0	0	2	0	0	1	0
15:45	0	0	0	0	0	0	0	1	0	0	0	0
16:00	0	0	0	0	0	0	0	2	0	0	1	0
16:15	0	0	0	0	0	0	0	0	0	0	0	0
16:30	0	1	0	0	4	0	0	2	0	0	2	0
16:45	0	0	0	0	2	0	0	2	0	0	0	0
17:00	0	0	0	0	0	0	0	3	0	0	0	0
17:15	0	0	0	0	0	0	0	0	0	0	0	0
17:30	0	0	0	0	0	0	0	1	0	0	0	0
17:45	0	0	0	0	0	0	0	2	0	0	0	0
18:00	0	0	0	0	0	0	0	0	0	0	0	0
18:15	0	0	0	0	0	0	0	0	0	0	0	0
18:30	0	0	0	0	0	0	0	0	0	0	0	0
18:45	0	0	0	0	0	0	0	0	0	0	0	0
19:00	0	0	0	0	0	0	0	2	0	0	1	0
19:15												
19:30												
19:45												
20:00												
20:15												
20:30												
20:45												
21:00												
21:15												
21:30												
21:45												
22:00												
22:15												
22:30												
22:45												
23:00												
23:15												
23:30												
23:45												
00:00												
TOTAL	0	2	0	1	8	7	0	51	0	0	15	0
AM Peak Vol	0	0	0	0	2	0	0	4	0	0	1	0
PM Peak Vol	0	0	0	0	2	0	0	6	0	0	0	0

Request No.:
 Job No.:

Location: Broadview Avenue @ Chappell Street
 Date: 10/23/2014 Thursday
 Recorder: BDD
 Interval (dd): 15
 (In Minutes)

County: Fauquier, VA
 Town: Warrenton
 Weather: Clear, Cool

PEAK HOURS	AM PERIOD	Start	End	Volume	PM PERIOD	Start	End	Volume
	6:00AM-12:00PM	11:00	12:00	2114	12:00PM-7:00PM	16:30	17:30	2867

Turning Movement Summary:

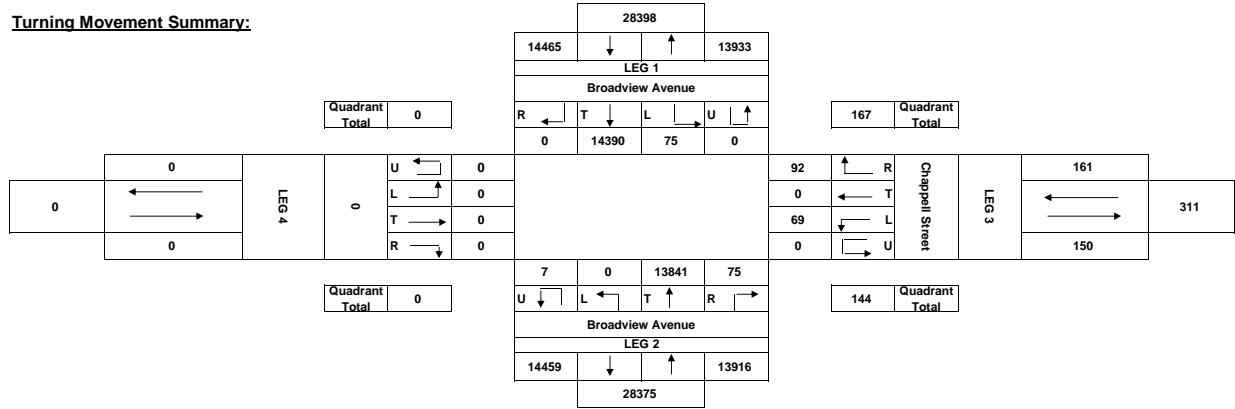

Comments:

AM Peak Hour : X:XX A.M. - X:XX A.M.

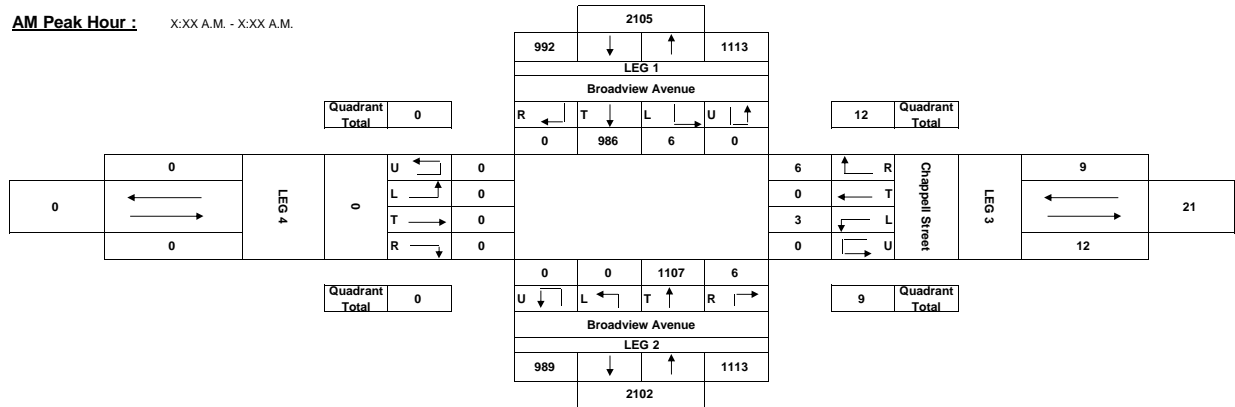

PM Peak Hour : X:XX P.M. - X:XX P.M.

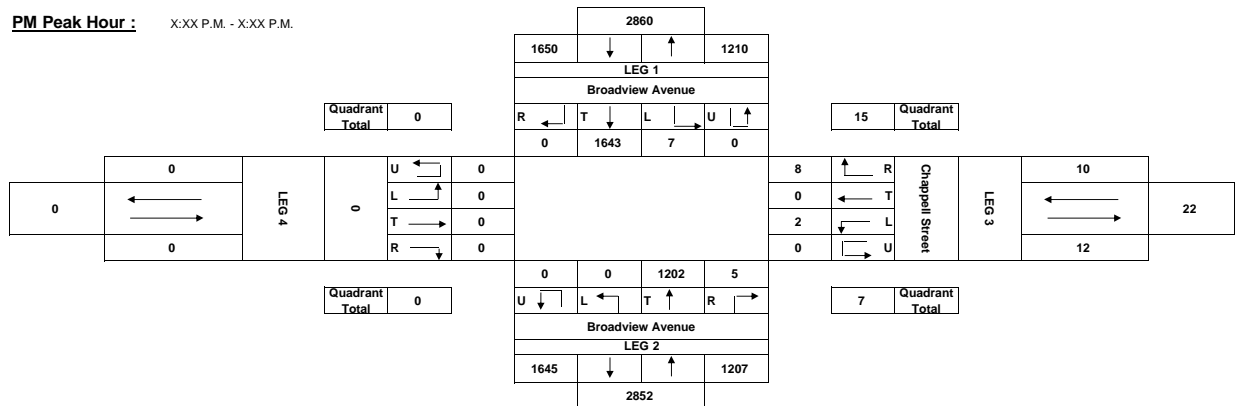

Request No.:
 Job No.:

Location: Broadview Avenue @ Roebing Street
Date: 10/23/2014 Thursday
Recorder: BJA
Interval (dd) : 15
 (In Minutes)

County: Fauquier, VA
Town: Warrenton
Weather: Clear, Cool

PEAK HOURS	AM PERIOD 6:00AM-12:00PM	Start	End	Volume	PM PERIOD 12:00PM-7:00PM	Start	End	Volume
		11:00	12:00	2144	16:15	17:15	2731	

PEDESTRIAN SCHOOL CHILDREN & U-TURN BREAKDOWN

Hour Ending	Broadview Avenue			Broadview Avenue			Roebing Street			Roebing Street		
	BIKES	PED.	U.T.	BIKES	PED.	U.T.	BIKES	PED.	U.T.	BIKES	PED.	U.T.
00:15												
00:30												
00:45												
01:00												
01:15												
01:30												
01:45												
02:00												
02:15												
02:30												
02:45												
03:00												
03:15												
03:30												
03:45												
04:00												
04:15												
04:30												
04:45												
05:00												
05:15												
05:30												
05:45												
06:00												
06:15	0	0	0	0	0	1	0	0	0	0	0	0
06:30	0	0	0	0	0	2	0	0	0	0	0	0
06:45	0	0	0	0	0	1	0	0	0	0	0	0
07:00	0	0	0	0	0	3	0	0	0	0	0	0
07:15	0	0	0	0	0	2	0	0	0	0	0	0
07:30	0	0	0	0	0	5	0	0	0	0	0	0
07:45	0	1	0	0	0	0	0	0	0	0	0	0
08:00	0	0	0	0	1	3	0	0	0	0	1	0
08:15	0	0	0	0	0	2	0	0	0	0	1	0
08:30	0	0	0	0	0	2	0	0	0	0	0	0
08:45	0	0	1	0	0	0	0	0	0	0	0	0
09:00	0	0	0	0	0	0	0	0	0	0	1	0
09:15	0	0	2	0	1	1	0	0	0	0	0	0
09:30	0	0	1	1	0	1	0	0	0	0	0	0
09:45	0	0	0	1	0	5	0	0	0	0	0	0
10:00	0	0	0	0	0	1	0	1	0	0	0	0
10:15	0	0	0	0	0	1	0	0	0	0	0	0
10:30	0	0	0	0	0	1	0	0	0	0	0	0
10:45	0	1	0	0	0	1	0	0	0	0	0	0
11:00	0	0	0	0	0	3	0	0	0	0	0	0
11:15	0	0	0	0	0	0	0	0	0	0	1	0
11:30	0	0	0	0	0	1	0	0	0	0	0	0
11:45	0	1	0	0	0	1	0	0	0	0	0	0
12:00	0	0	1	0	0	4	0	0	0	0	0	0
12:15	0	0	1	0	0	1	0	0	0	0	2	0
12:30	0	0	1	0	0	3	0	0	0	0	0	0
12:45	0	0	0	0	1	0	0	0	0	0	0	0
13:00	0	0	0	0	0	2	0	2	0	0	0	0
13:15	0	0	0	0	0	1	0	0	0	0	0	0
13:30	0	0	1	0	0	1	0	0	0	0	1	0
13:45	0	0	0	0	0	1	0	0	0	0	0	0
14:00	0	0	1	0	0	2	0	1	0	0	0	0
14:15	0	1	2	0	1	2	0	0	0	0	1	0
14:30	0	0	4	0	0	0	0	0	0	0	0	0
14:45	0	0	1	0	0	1	0	0	0	0	2	0
15:00	0	0	1	0	0	1	0	0	0	0	0	0
15:15	0	0	3	0	0	0	0	0	0	0	1	0
15:30	0	2	1	0	1	0	0	0	0	0	2	0
15:45	0	1	0	0	0	0	0	1	0	0	1	0
16:00	0	0	0	0	0	0	0	0	0	0	0	0
16:15	0	1	2	0	0	2	0	0	0	0	2	0
16:30	0	0	1	0	1	3	0	0	0	0	3	0
16:45	0	0	2	0	0	3	0	0	0	0	1	0
17:00	0	0	1	0	0	1	0	0	0	0	0	0
17:15	0	0	1	0	0	0	0	0	0	0	0	0
17:30	0	1	0	0	0	0	0	1	0	0	0	0
17:45	0	0	0	0	0	3	0	0	0	0	0	0
18:00	0	0	0	0	0	1	0	0	0	0	0	0
18:15	0	0	0	0	0	3	0	0	0	0	0	0
18:30	0	0	0	0	0	1	0	0	0	0	0	0
18:45	0	0	0	0	0	1	0	0	0	0	0	0
19:00	0	0	1	0	0	1	0	0	0	0	0	0
19:15												
19:30												
19:45												
20:00												
20:15												
20:30												
20:45												
21:00												
21:15												
21:30												
21:45												
22:00												
22:15												
22:30												
22:45												
23:00												
23:15												
23:30												
23:45												
00:00												
TOTAL	0	9	29	1	7	75	0	6	0	0	20	0
AM Peak Vol	0	1	1	0	0	6	0	0	0	0	1	0
PM Peak Vol	0	0	5	0	1	7	0	0	0	0	4	0

Request No.:
 Job No.:

Location: Broadview Avenue @ Roebling Street
 Date: 10/23/2014 Thursday
 Recorder: BJA
 Interval (dd): 15
 (In Minutes)

County: Fauquier, VA
 Town: Warrenton
 Weather: Clear, Cool

PEAK HOURS	AM PERIOD	Start	End	Volume	PM PERIOD	Start	End	Volume
	6:00AM-12:00PM	11:00	12:00	2144	12:00PM-7:00PM	16:15	17:15	2731

Turning Movement Summary:

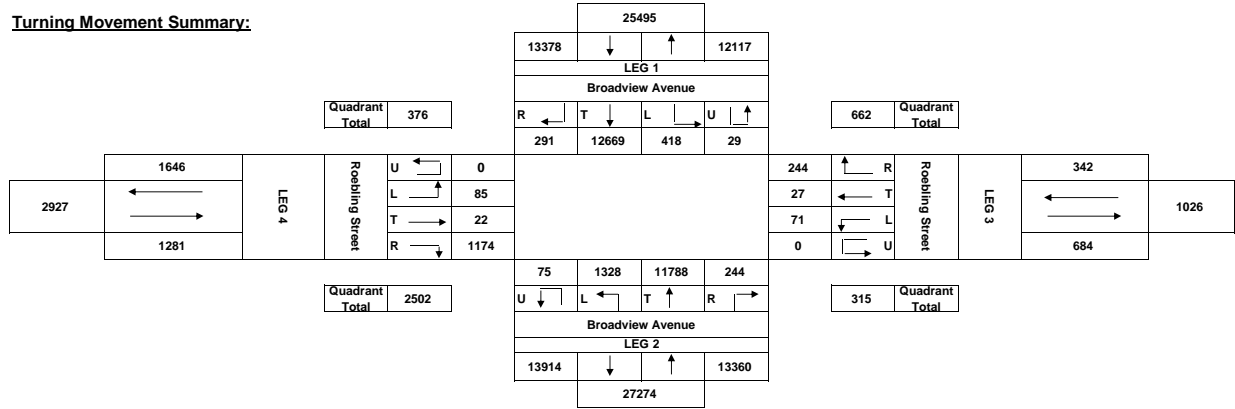

Comments:

AM Peak Hour : X:XX A.M. - X:XX A.M.

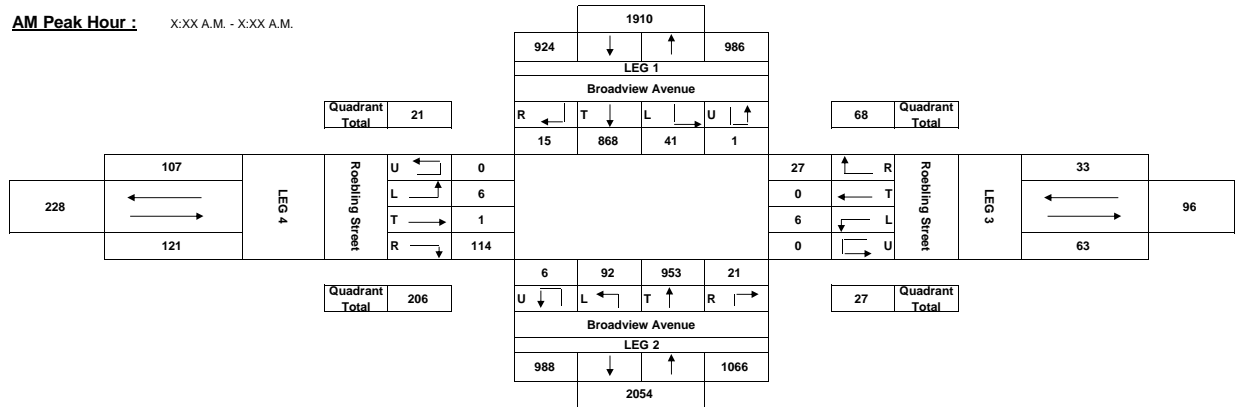

PM Peak Hour : X:XX P.M. - X:XX P.M.

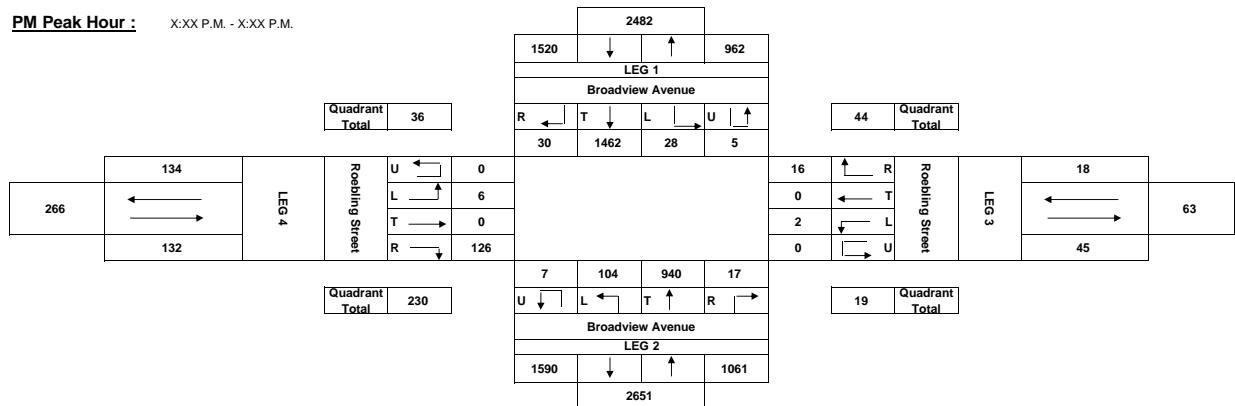

Request No.:
 Job No.:

Location: Broadview Avenue/E. Lee Highway @ Winchester Street
 Date: 10/23/2014 Thursday
 Recorder: C/JG, SNC
 Interval (dd): 15
 (In Minutes)

County: Fauquier, VA
 Town: Warrenton
 Weather: Clear, Cool

PEAK HOURS	AM PERIOD	Start	End	Volume	PM PERIOD	Start	End	Volume
	6:00AM-12:00PM	11:00	12:00	2446	12:00PM-7:00PM	16:30	17:30	3437

Turning Movement Summary:

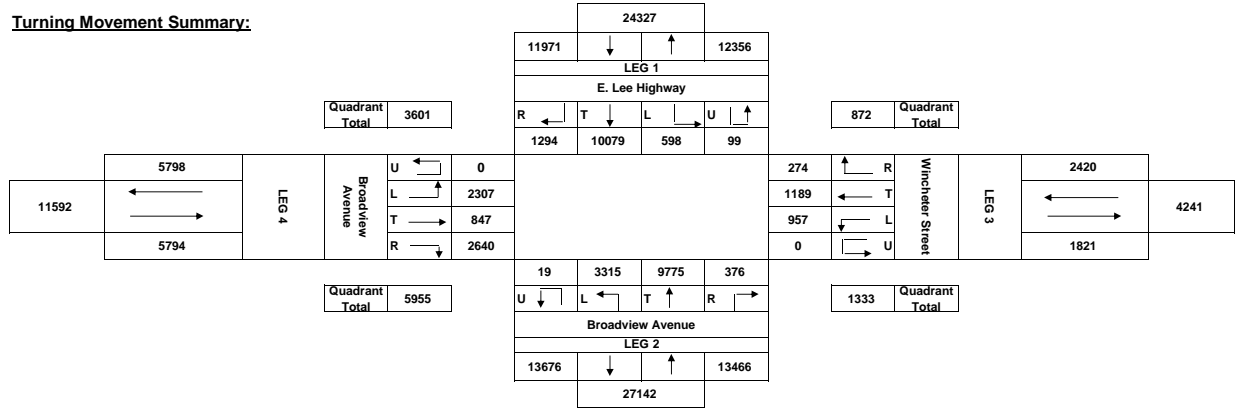

AM Peak Hour : X:XX A.M. - X:XX A.M.

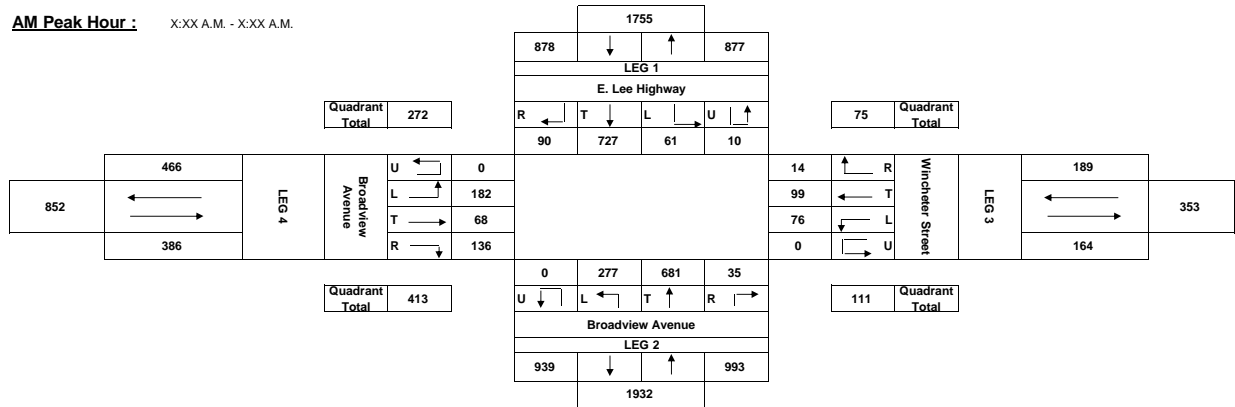

PM Peak Hour : X:XX P.M. - X:XX P.M.

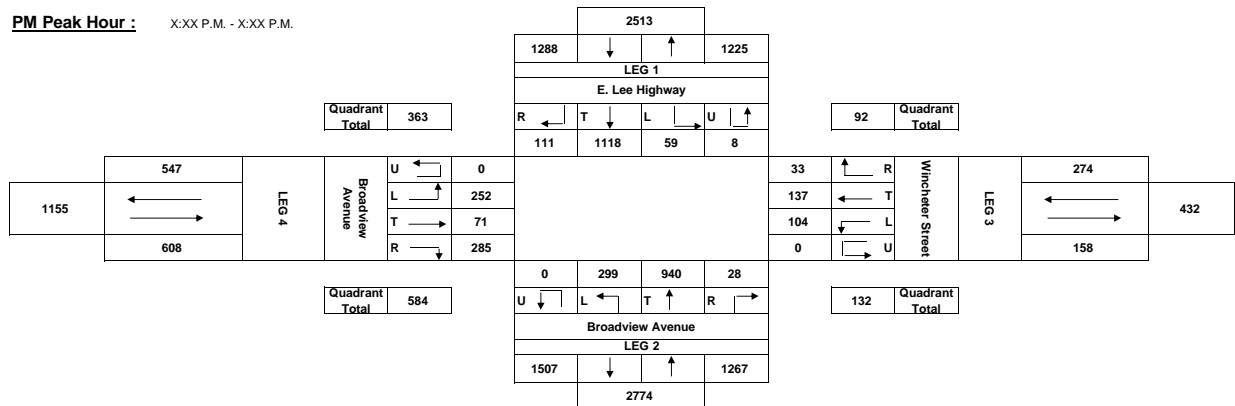

Request No.:
 Job No.:

Location: Broadview Avenue/ W. Shirley Avenue @ Frost Avenue/ Waterloo Street
 Date: 10/25/2014 Saturday
 Recorder: OJG, JWL
 Interval (dd) : 15
 (In Minutes)

County: Fauquier, VA
 Town: Warrenton
 Weather: Clear, Cool

PEAK HOURS	AM PERIOD 6:00AM-12:00PM	Start 11:00	End 12:00	Volume 3532	PM PERIOD 12:00PM-7:00PM	Start 12:00	End 13:00	Volume 3185
------------	--------------------------	-------------	-----------	-------------	--------------------------	-------------	-----------	-------------

PEDESTRIAN SCHOOL CHILDREN & U-TURN BREAKDOWN

Hour Ending	Broadview Avenue			W. Shirley Avenue			Waterloo Street			Frost Avenue		
	BIKES	PED.	U.T.	BIKES	PED.	U.T.	BIKES	PED.	U.T.	BIKES	PED.	U.T.
00:15												
00:30												
00:45												
01:00												
01:15												
01:30												
01:45												
02:00												
02:15												
02:30												
02:45												
03:00												
03:15												
03:30												
03:45												
04:00												
04:15												
04:30												
04:45												
05:00												
05:15												
05:30												
05:45												
06:00												
06:15	0	0	0	0	0	0	0	0	0	0	0	0
06:30	0	0	0	0	0	0	0	0	0	0	2	1
06:45	0	0	0	0	0	0	0	0	0	0	0	0
07:00	0	0	0	0	0	0	0	0	0	0	0	0
07:15	0	0	1	0	0	0	0	0	0	0	4	0
07:30	0	0	0	0	0	0	0	0	0	0	0	0
07:45	0	0	0	0	0	1	0	0	0	0	0	1
08:00	0	0	0	0	0	0	0	0	0	0	0	0
08:15	0	0	0	0	0	0	0	0	0	0	0	1
08:30	0	0	0	0	0	0	0	0	0	0	0	0
08:45	0	1	0	0	3	0	0	0	0	0	1	0
09:00	0	1	0	0	0	0	0	0	1	0	0	0
09:15	0	14	0	0	0	0	0	0	0	0	3	0
09:30	0	0	0	0	0	0	0	0	0	0	0	0
09:45	0	0	0	0	0	0	0	0	0	0	0	0
10:00	0	0	0	0	4	0	0	0	0	0	0	0
10:15	0	0	0	0	0	0	0	0	0	0	0	0
10:30	0	0	0	0	0	0	0	0	0	0	0	0
10:45	0	0	0	0	0	0	0	0	0	0	1	0
11:00	0	0	0	0	0	0	0	0	1	0	0	1
11:15	0	0	0	0	0	0	0	0	0	0	0	3
11:30	0	0	0	0	0	0	0	0	1	0	0	2
11:45	0	0	0	0	0	0	0	0	0	0	0	1
12:00	0	0	1	0	0	0	0	0	0	0	0	0
12:15	0	0	0	0	0	1	0	0	0	0	0	1
12:30	1	0	0	0	1	0	0	0	0	0	1	2
12:45	0	1	0	0	0	0	0	0	0	0	0	1
13:00	0	0	0	0	0	0	0	0	0	0	0	0
13:15	0	1	0	0	0	0	0	0	0	0	0	0
13:30	0	0	0	0	1	0	0	0	0	0	0	2
13:45	0	0	0	0	0	0	0	0	0	0	1	1
14:00	0	0	0	0	0	0	0	0	0	0	1	0
14:15	0	1	0	0	0	0	0	0	0	0	0	0
14:30	0	0	0	0	0	0	0	0	0	0	1	3
14:45	0	1	0	0	1	0	0	0	0	0	0	0
15:00	0	0	0	0	0	0	0	0	0	0	0	0
15:15	0	0	0	0	0	0	0	0	1	0	0	0
15:30	0	1	0	0	0	0	0	0	1	0	0	0
15:45	0	0	0	0	0	1	0	0	0	1	0	0
16:00	0	1	0	0	1	0	0	0	0	0	1	0
16:15	0	2	0	0	0	0	0	0	0	0	1	1
16:30	0	0	0	0	0	0	0	0	0	0	0	0
16:45	0	0	0	0	1	0	0	0	0	0	1	0
17:00	0	1	0	0	0	0	0	0	0	0	1	0
17:15	0	4	0	0	0	0	0	0	4	0	0	0
17:30	0	2	0	0	1	0	0	0	0	0	0	0
17:45	0	3	0	0	0	0	0	0	0	0	0	1
18:00	0	0	0	0	0	0	0	0	1	0	0	0
18:15	0	0	0	0	0	0	0	0	0	0	0	0
18:30	0	1	1	0	0	0	0	0	0	0	0	0
18:45	0	3	0	0	0	0	0	0	2	0	0	1
19:00	0	0	1	0	0	0	0	0	0	0	0	0
19:15												
19:30												
19:45												
20:00												
20:15												
20:30												
20:45												
21:00												
21:15												
21:30												
21:45												
22:00												
22:15												
22:30												
22:45												
23:00												
23:15												
23:30												
23:45												
00:00												
TOTAL	1	38	4	0	13	3	0	12	1	0	22	23
AM Peak Vol	0	0	1	0	0	0	0	1	0	0	0	6
PM Peak Vol	1	1	0	0	1	1	0	0	0	0	1	4

Request No.:
 Job No.:

Location: Broadview Avenue/ W. Shirley Avenue @ Frost Avenue/ Waterloo Street
 Date: 10/25/2014 Saturday
 Recorder: CJG, JWL
 Interval (dd): 15
 (In Minutes)

County: Fauquier, VA
 Town: Warrenton
 Weather: Clear, Cool

PEAK HOURS	AM PERIOD	Start	End	Volume	PM PERIOD	Start	End	Volume
	6:00AM-12:00PM	11:00	12:00	3532	12:00PM-7:00PM	12:00	13:00	3185

Turning Movement Summary:

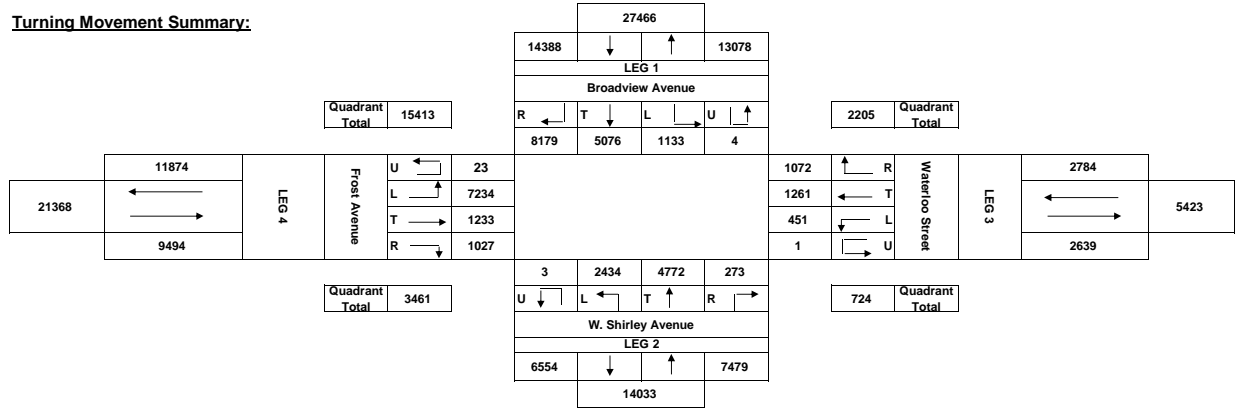

Comments:

AM Peak Hour : X:XX A.M. - X:XX A.M.

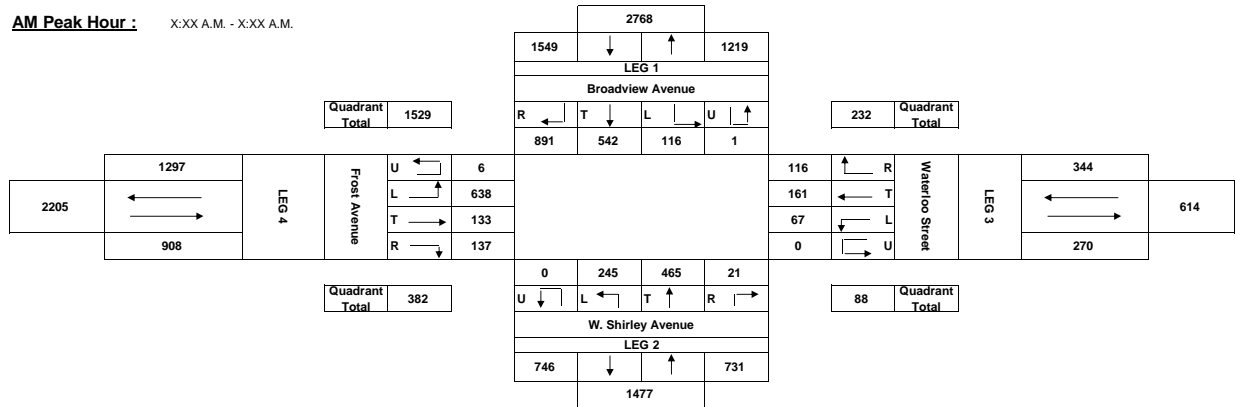

PM Peak Hour : X:XX P.M. - X:XX P.M.

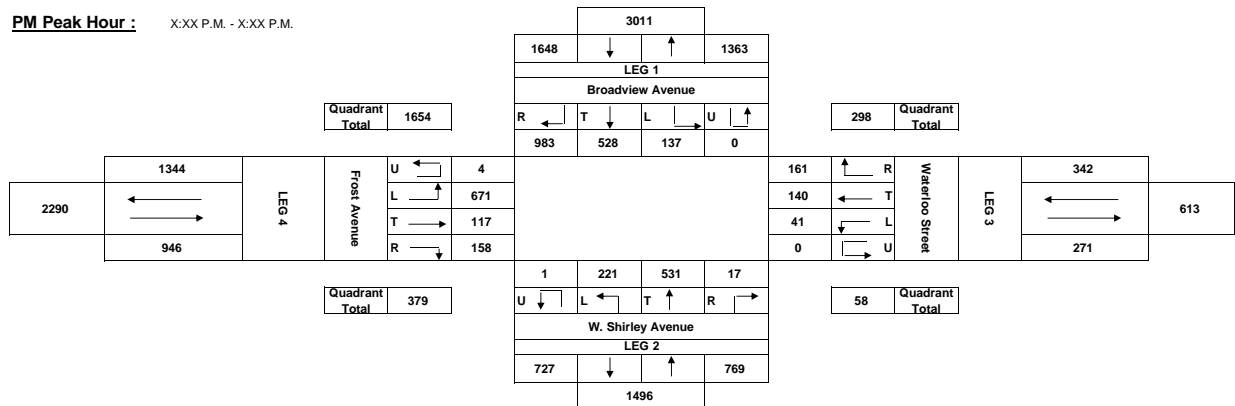

Request No.:
 Job No.:

Location: Broadview Avenue @ Church Street
 Date: 10/25/2014 Saturday
 Recorder: BJE, BJA
 Interval (dd): 15
 (In Minutes)

County: Fauquier, VA
 Town: Warrenton
 Weather: Clear, Cool

PEAK HOURS	AM PERIOD	Start	End	Volume	PM PERIOD	Start	End	Volume
	6:00AM-12:00PM	11:00	12:00	2792	12:00PM-7:00PM	12:00	13:00	2578

Turning Movement Summary:

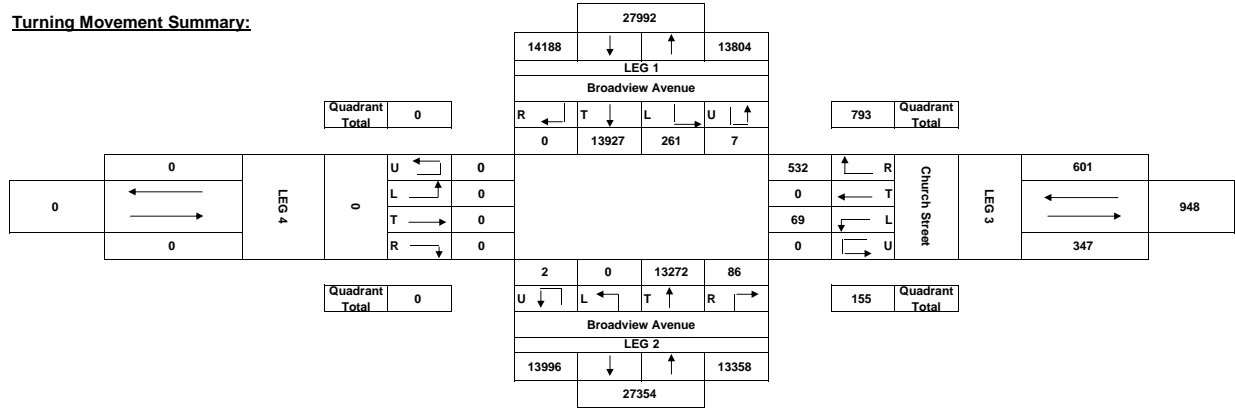

Comments:

AM Peak Hour : X:XX A.M. - X:XX A.M.

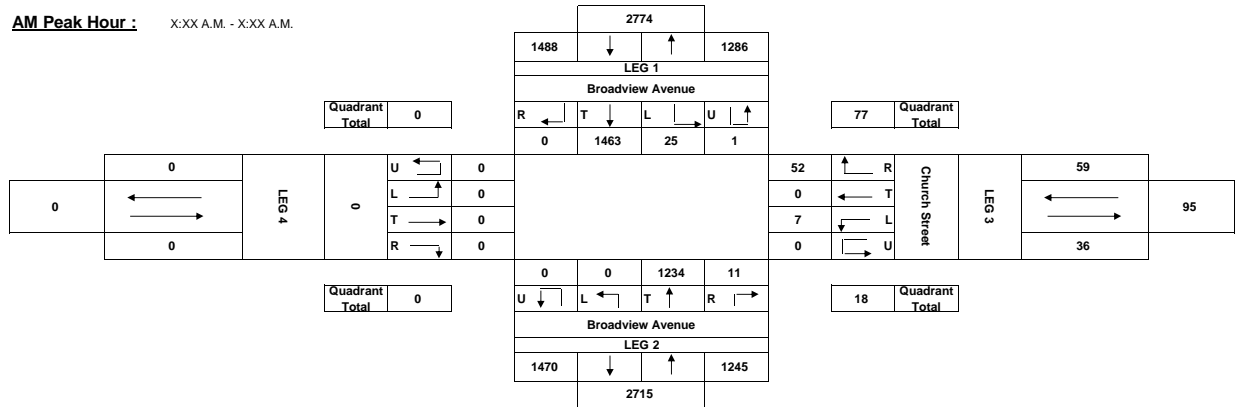

PM Peak Hour : X:XX P.M. - X:XX P.M.

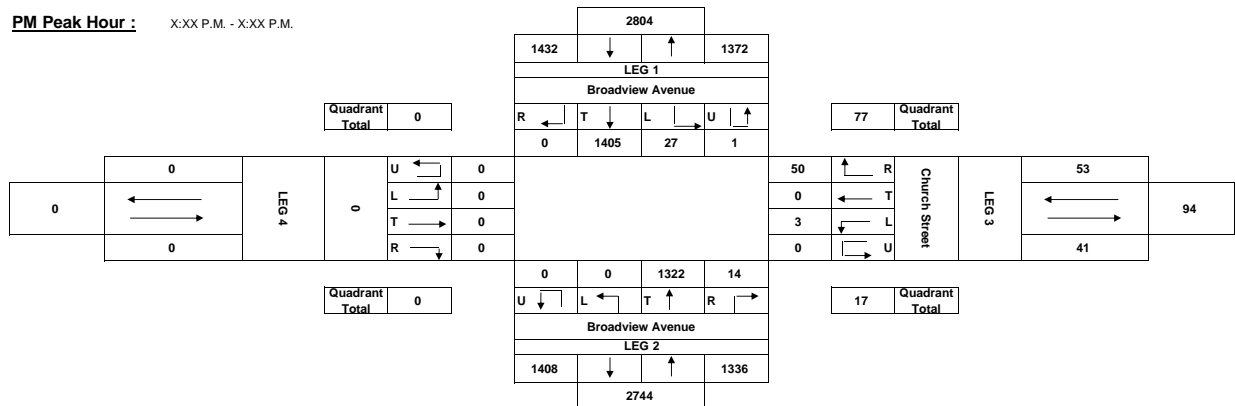

Request No.:
Job No.:

Location: Broadview Avenue @ Stuyvesant Street/ Gold Cup Drive
 Date: 10/25/2014 Saturday
 Recorder: EPC, GNC
 Interval (dd): 15
 (In Minutes)
 County: Fauquier, VA
 Town: Warrenton
 Weather: Clear, Cool

PEAK HOURS	AM PERIOD 6:00AM-12:00PM	Start	End	Volume	PM PERIOD 12:00PM-7:00PM	Start	End	Volume
		11:00	12:00	3175		12:45	13:45	3379

Street Name->	Broadview Avenue				Broadview Avenue				Stuyvesant Street				Gold Cup Drive				GRAND TOTAL
	From North		R	TOT	From South		R	TOT	From East		R	TOT	From West		R	TOT	
	L	T			L	T			L	T			L	T			
00:15			0													0	
11:15	3	321	3	327	2	304	1	307	5	0	3	8	3	0	3	6	
11:30	0	280	1	281	2	391	2	395	4	0	5	9	1	0	2	3	
11:45	1	392	1	394	2	434	1	437	3	0	1	4	6	0	3	9	
12:00	0	483	0	483	0	502	1	503	3	0	1	4	3	0	2	5	
12:15	1	428	7	436	1	494	2	497	0	0	1	1	5	0	3	8	
12:30	0	353	5	358	2	350	0	352	4	0	2	6	7	0	7	7	
12:45	0	289	3	292	0	391	0	391	9	0	7	16	1	0	1	7	
13:00	0	378	0	378	2	466	2	470	3	0	1	2	0	5	7	7	
13:15	2	427	5	434	1	510	2	513	1	0	3	4	6	0	4	10	
13:30	2	366	10	378	1	521	0	522	4	0	5	9	5	0	5	10	
13:45	0	381	8	389	1	408	6	415	1	0	0	1	5	1	5	11	
14:00	3	371	4	378	4	283	0	287	3	0	3	6	7	0	3	10	
14:15	0	329	6	335	2	360	5	367	4	0	1	5	5	0	6	11	
14:30	0	372	7	379	1	339	1	341	0	0	0	5	0	2	7	7	
14:45	0	306	6	312	6	385	3	394	3	0	1	4	5	0	6	11	
15:00	1	332	10	343	5	357	2	364	1	0	1	2	5	0	7	12	
15:15	1	361	4	366	2	282	2	286	0	1	0	1	3	0	3	6	
15:30	1	341	9	351	3	351	1	355	1	0	0	1	3	0	3	6	
15:45	0	335	1	336	1	460	0	461	2	0	3	5	3	0	1	4	
16:00	0	314	1	315	2	360	2	364	1	0	1	2	2	0	1	3	
16:15	1	323	1	325	0	366	1	367	0	0	1	1	5	0	1	5	
16:30	0	344	1	345	4	443	2	449	1	0	1	2	4	0	1	5	
16:45	3	401	2	406	0	392	0	392	2	0	2	4	6	0	4	10	
17:00	0	326	3	329	2	456	3	461	1	0	1	2	10	1	6	17	
17:15	0	301	4	305	1	458	2	461	1	0	2	3	21	2	2	25	
17:30	1	326	2	329	0	406	1	407	3	0	1	4	17	0	7	24	
17:45	1	353	0	354	3	478	0	481	0	0	0	5	1	3	9	844	
18:00	1	380	6	387	0	440	2	442	4	0	4	9	0	2	11	844	
18:15	3	414	8	425	2	453	3	458	1	0	1	2	9	0	7	16	901
18:30	1	325	0	326	0	452	1	453	1	0	1	2	3	0	2	5	786
18:45	2	275	1	278	2	551	2	555	2	0	4	6	6	0	3	9	848
19:00	1	280	2	283	1	491	1	493	4	0	2	6	3	1	2	6	788
19:15			0													0	
19:30			0													0	
19:45			0													0	
20:00			0													0	
20:15			0													0	
20:30			0													0	
20:45			0													0	
21:00			0													0	
21:15			0													0	
21:30			0													0	
21:45			0													0	
22:00			0													0	
22:15			0													0	
22:30			0													0	
22:45			0													0	
23:00			0													0	
23:15			0													0	
23:30			0													0	
23:45			0													0	
00:00			0													0	
TOTAL	39	15490	186	15715	106	17469	92	17667	122	6	85	213	270	8	175	453	34048
AM Peak Vol	4	1476	5	1485	6	1631	5	1642	15	0	10	25	13	0	10	23	3175
PM Peak Vol	4	1552	23	1579	5	1905	10	1920	9	0	9	18	18	1	19	38	3555

Request No.:
 Job No.:

Location: Broadview Avenue @ Stuyvesant Street/ Gold Cup Drive
 Date: 10/25/2014 Saturday
 Recorder: EPC, GNC
 Interval (dd): 15
 (In Minutes)

County: Fauquier, VA
 Town: Warrenton
 Weather: Clear, Cool

PEAK HOURS	AM PERIOD	Start	End	Volume	PM PERIOD	Start	End	Volume
	6:00AM-12:00PM	11:00	12:00	3175	12:00PM-7:00PM	12:45	13:45	3379

Turning Movement Summary:

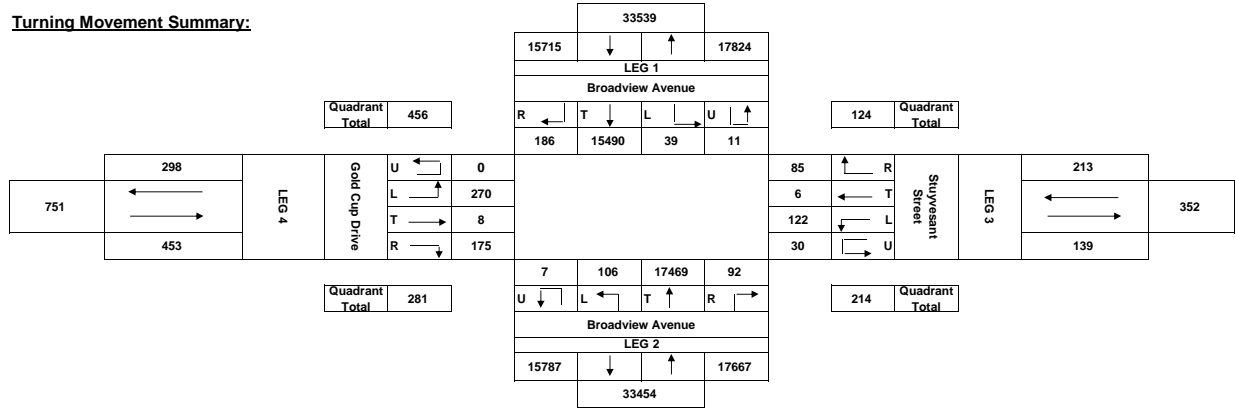

Comments:

AM Peak Hour : X:XX A.M. - X:XX A.M.

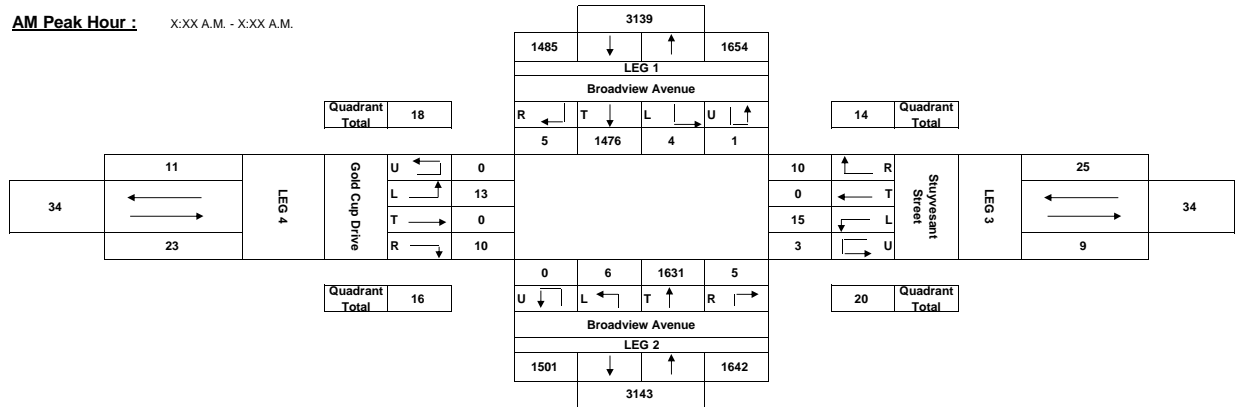

PM Peak Hour : X:XX P.M. - X:XX P.M.

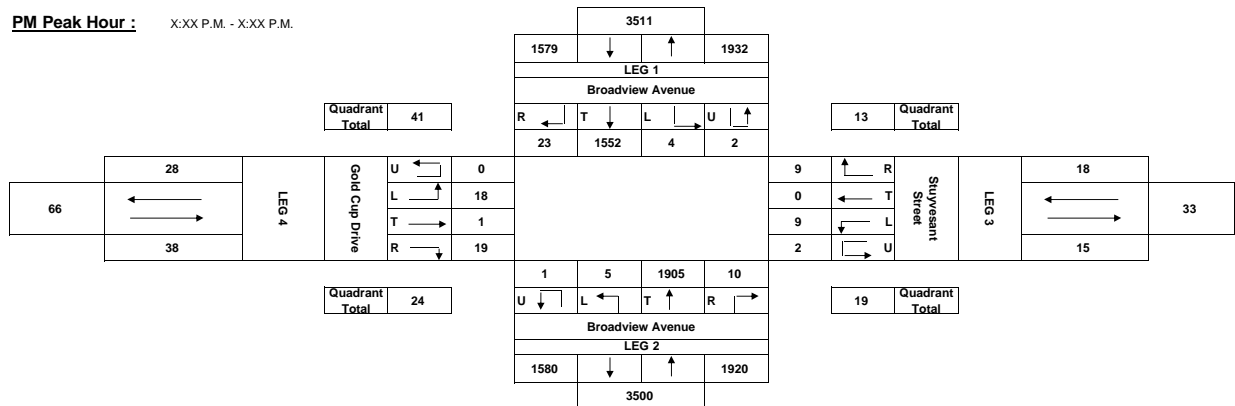

Request No.:
 Job No.:

Location: Broadview Avenue @ Chappell Street
 Date: 10/25/2014 Saturday
 Recorder: JRG, GNC
 Interval (dd): 15
 (In Minutes)

County: Fauquier, VA
 Town: Warrenton
 Weather: Clear, Cool

PEAK HOURS	AM PERIOD	Start	End	Volume	PM PERIOD	Start	End	Volume
	6:00AM-12:00PM	11:00	12:00	2830	12:00PM-7:00PM	12:00	13:00	2745

Turning Movement Summary:

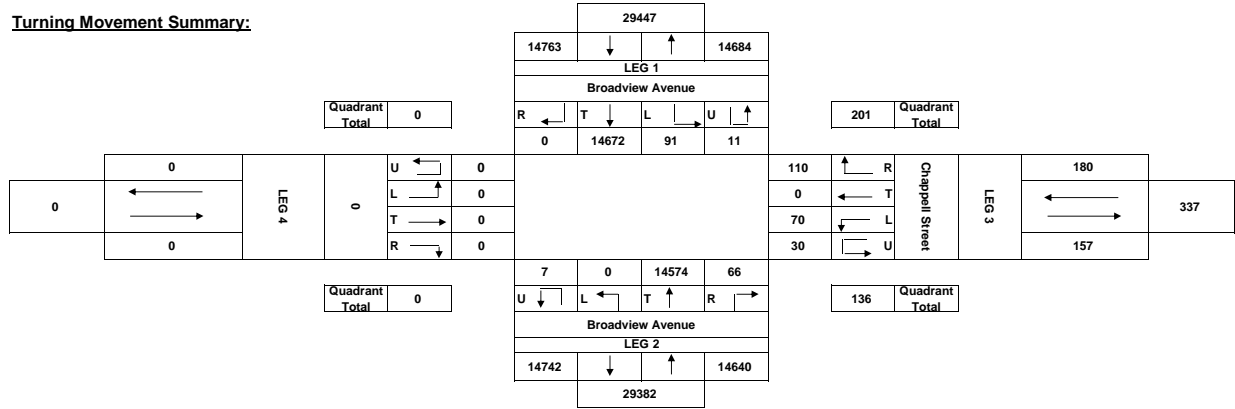

Comments:

AM Peak Hour : X:XX A.M. - X:XX A.M.

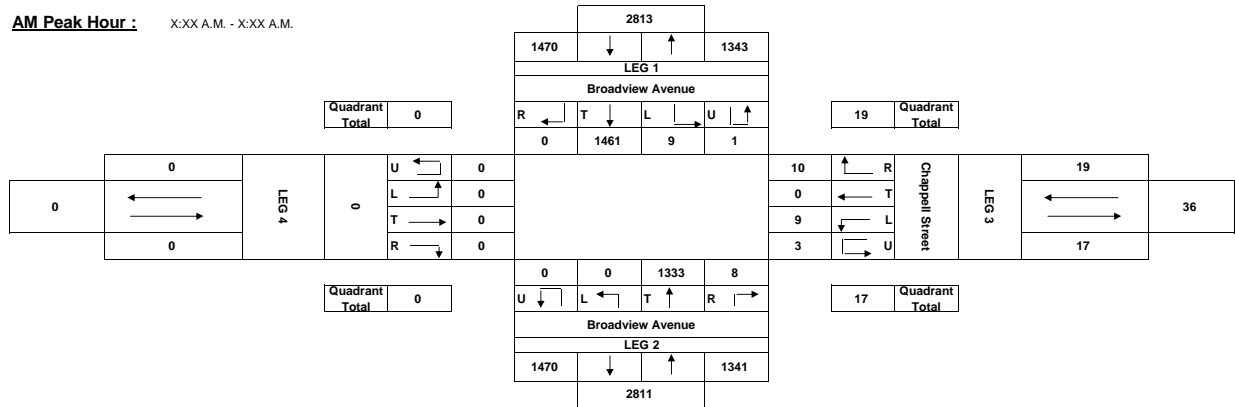

PM Peak Hour : X:XX P.M. - X:XX P.M.

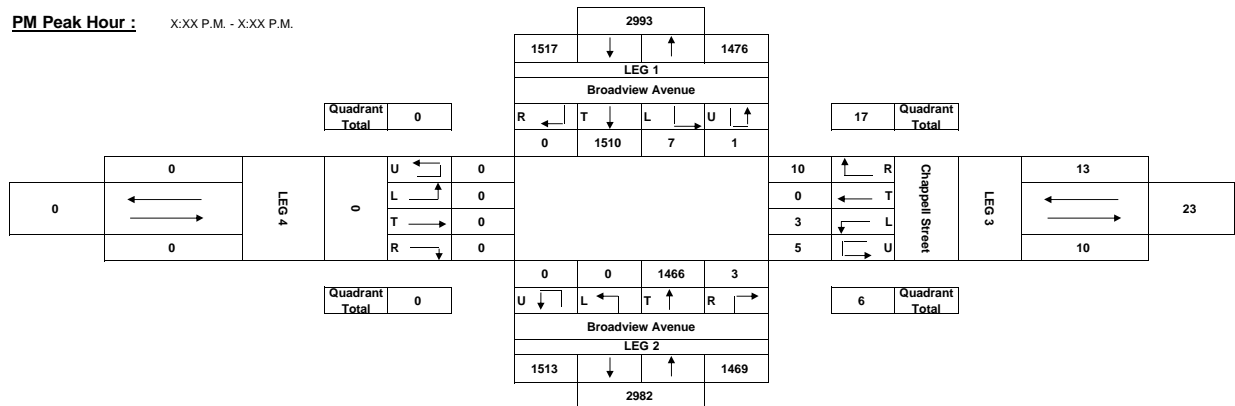

Request No.:
 Job No.:

Location: Broadview Avenue @ Roebing Street
Date: 10/25/2014 Saturday
Recorder: RWE, SNC
Interval (dd): 15
(In Minutes)
County: Fauquier, VA
Town: Warrenton
Weather: Clear, Cool

Summary table with columns: AM PERIOD (6:00AM-12:00PM), Start (11:00), End (12:00), Volume (2924), PM PERIOD (12:00PM-7:00PM), Start (12:00), End (13:00), Volume (2884)

Main data table with columns: Street Name, HOUR ENDING, and multiple columns for street directions: Broadview Avenue From North, Broadview Avenue From South, Roebing Street From East, Roebing Street From West. Includes a GRAND TOTAL column on the right.

TOTAL summary table with columns: TOTAL, 468, 13946, 233, 14647, 1130, 13420, 258, 14808, 87, 16, 331, 434, 57, 20, 976, 1053, 30942

Request No.:
 Job No.:

Location: Broadview Avenue @ Roebling Street
 Date: 10/25/2014 Saturday
 Recorder: RWE, SNC
 Interval (dd): 15
 (In Minutes)

County: Fauquier, VA
 Town: Warrenton
 Weather: Clear, Cool

PEAK HOURS	AM PERIOD	Start	End	Volume	PM PERIOD	Start	End	Volume
	6:00AM-12:00PM	11:00	12:00	2924	12:00PM-7:00PM	12:00	13:00	2884

Turning Movement Summary:

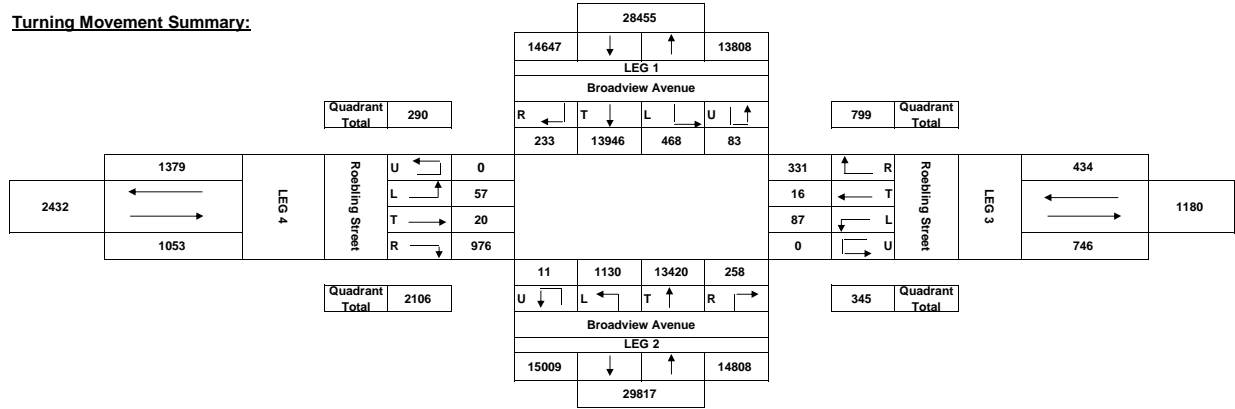

Comments:

AM Peak Hour : X:XX A.M. - X:XX A.M.

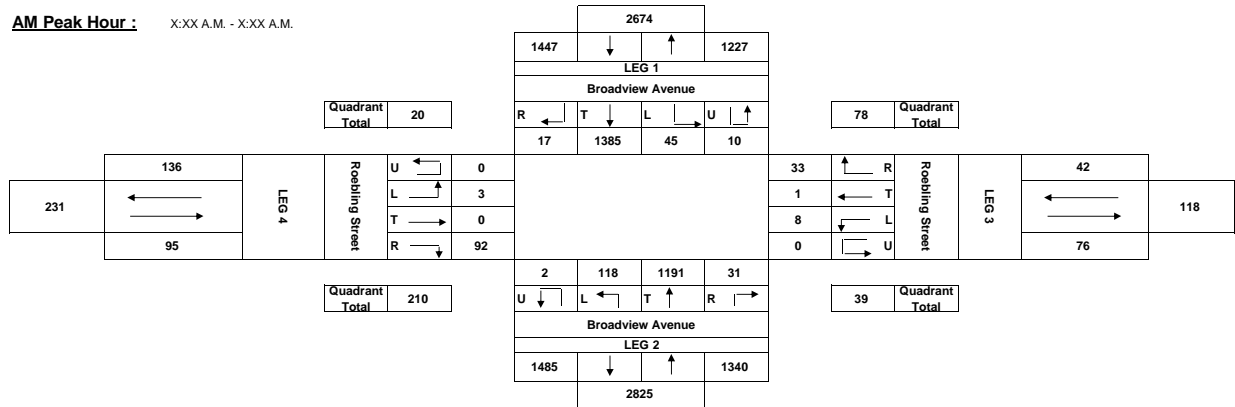

PM Peak Hour : X:XX P.M. - X:XX P.M.

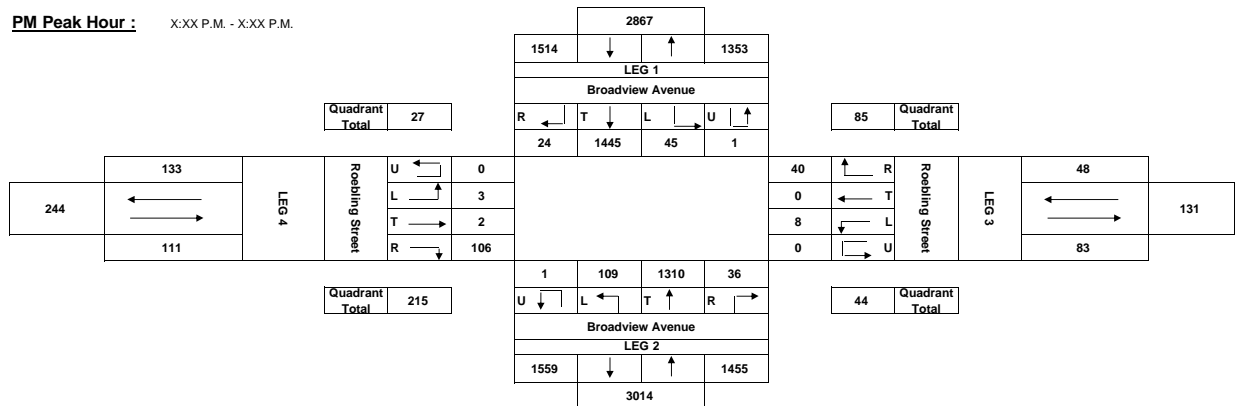

Request No.:
Job No.:

Location: Broadview Avenue/E. Lee Highway @ Winchester Street
Date: 10/25/2014 Saturday
Recorder: JLK, BDD
Interval (dd): 15
(In Minutes)

County: Fauquier, VA
Town: Warrenton
Weather: Clear, Cool

PEAK HOURS	AM PERIOD 6:00AM-12:00PM	Start			Volume 3332	PM PERIOD 12:00PM-7:00PM			Start			Volume 3263
		11:00	12:00	12:00		12:00	13:00	12:00	13:00			

Street

Name--> HOUR ENDING	E. Lee Highway			Broadview Avenue			Winchester Street			Broadview Avenue			GRAND TOTAL		
	From North			From South			From East			From West					
	L	T	R	TOT	L	T	R	TOT	L	T	R	TOT			
00:15				0				0				0	0		
00:30				0				0				0	0		
00:45				0				0				0	0		
01:00				0				0				0	0		
01:15				0				0				0	0		
01:30				0				0				0	0		
01:45				0				0				0	0		
02:00				0				0				0	0		
02:15				0				0				0	0		
02:30				0				0				0	0		
02:45				0				0				0	0		
03:00				0				0				0	0		
03:15				0				0				0	0		
03:30				0				0				0	0		
03:45				0				0				0	0		
04:00				0				0				0	0		
04:15				0				0				0	0		
04:30				0				0				0	0		
04:45				0				0				0	0		
05:00				0				0				0	0		
05:15				0				0				0	0		
05:30				0				0				0	0		
05:45				0				0				0	0		
06:00				0				0				0	0		
06:15	1	46	1	48	5	44	1	50	1	1	2	4	6	111	
06:30	1	51	2	54	4	54	1	59	1	0	0	1	2	10	127
06:45	5	65	10	80	11	52	3	66	1	0	0	1	7	2	169
07:00	3	65	9	77	8	63	4	75	0	1	2	3	7	1	169
07:15	5	68	2	75	8	64	2	74	2	2	0	4	13	2	188
07:30	4	109	4	117	20	93	6	119	0	0	1	1	11	1	265
07:45	7	156	12	175	19	85	4	108	8	4	1	13	11	9	359
08:00	11	197	16	224	27	105	6	138	3	1	1	5	28	11	445
08:15	5	186	17	208	39	103	9	151	7	15	2	24	22	7	442
08:30	4	193	7	204	34	125	4	163	7	34	4	45	22	9	485
08:45	9	222	10	241	45	141	2	188	7	4	3	14	25	15	530
09:00	3	228	21	252	44	161	7	212	12	10	1	23	35	16	584
09:15	10	215	23	248	55	157	10	222	16	26	5	47	32	16	616
09:30	10	224	12	246	58	186	6	250	23	16	4	42	27	11	631
09:45	21	256	19	296	61	160	10	231	23	21	8	52	43	13	677
10:00	9	266	28	303	57	165	10	232	25	26	3	54	41	18	714
10:15	12	228	30	270	73	205	12	290	25	15	6	46	24	21	690
10:30	15	264	34	313	58	196	7	261	22	23	2	47	24	11	834
10:45	12	286	21	319	95	222	7	324	22	21	5	48	33	21	787
11:00	8	314	38	360	70	220	10	300	18	20	5	43	39	12	812
11:15	14	316	28	358	78	206	7	291	13	13	9	35	37	19	803
11:30	20	276	28	324	95	220	10	325	26	34	7	67	54	20	850
11:45	36	277	27	340	60	236	23	319	22	31	14	67	33	13	834
12:00	10	275	34	319	88	234	12	334	27	24	12	63	38	9	821
12:15	15	284	20	319	88	274	12	374	21	30	10	61	37	25	878
12:30	20	275	14	309	101	242	10	353	26	25	21	72	45	20	859
12:45	16	292	30	338	80	208	9	297	30	37	10	77	34	12	808
13:00	12	290	22	324	82	212	9	303	25	33	3	61	41	14	801
13:15	15	280	26	324	95	237	6	328	21	25	11	57	39	17	822
13:30	18	250	31	299	67	260	4	331	16	27	17	60	57	14	804
13:45	8	184	26	218	73	221	2	246	14	30	13	57	43	9	670
14:00	25	275	26	326	85	249	10	344	22	16	3	41	33	12	811
14:15	16	224	23	263	71	226	6	303	19	31	7	57	37	12	727
14:30	20	274	26	320	82	242	11	335	12	15	7	34	54	17	813
14:45	9	275	43	327	76	249	11	336	17	30	3	50	52	17	849
15:00	8	263	32	303	92	229	8	329	17	30	11	58	38	14	810
15:15	20	275	29	324	63	226	10	299	18	16	12	46	47	17	791
15:30	21	243	23	287	61	211	11	283	17	14	9	40	38	15	747
15:45	25	227	21	274	58	274	7	339	14	16	8	38	52	19	845
16:00	17	181	25	223	61	226	9	296	14	14	9	37	37	14	668
16:15	16	219	26	261	72	267	6	345	16	16	3	35	37	22	749
16:30	15	197	24	236	68	210	6	284	17	17	13	47	50	19	688
16:45	19	209	25	253	75	263	8	346	15	18	19	52	53	20	778
17:00	20	178	18	216	64	267	8	309	13	16	13	42	53	23	735
17:15	19	177	22	218	60	247	4	311	11	17	14	42	62	24	716
17:30	14	184	23	221	50	266	8	324	17	12	15	44	78	36	775
17:45	14	150	19	183	48	251	4	303	17	19	15	51	75	25	695
18:00	10	154	24	188	32	272	7	311	24	29	15	68	61	20	730
18:15	11	202	21	234	67	289	7	363	20	32	15	67	41	14	772
18:30	12	178	19	209	62	194	11	267	15	15	12	42	50	11	623
18:45	13	184	22	219	66	241	11	318	12	8	7	27	37	12	652
19:00	22	162	30	214	69	210	7	286	11	13	10	34	49	25	652
19:15				0				0				0			0
19:30				0				0				0			0
19:45				0				0				0			0
20:00				0				0				0			0
20:15				0				0				0			0
20:30				0				0				0			0
20:45				0				0				0			0
21:00				0				0				0			0
21:15				0				0				0			0
21:30				0				0				0			0
21:45				0				0				0			0
22:00				0				0				0			0
22:15				0				0				0			0
22:30				0				0				0			0
22:45				0				0				0			0
23:00				0				0				0			0
23:15				0				0				0			0
23:30				0				0				0			0
23:45				0				0				0			0
00:00				0				0				0			0

TOTAL	686	11069	1123	12878	3080	10260	395	13735	801	943	402	2146	1941	757	2619	5317	34076
AM Peak Vol	80	1144	117	1341	321	896	52	1269	88	102	42	232	162	61	267	490	3332
PM Peak Vol	63	1141	86	1290	351	936	40	1327	102	125	44	271	157	71	230	458	3346

Request No.:
 Job No.:

Location: Broadview Avenue / E. Lee Highway @ Winchester Street County: Fauquier, VA
 Date: 10/25/2014 Saturday Town: Warrenton
 Recorder: JLR, BDD Weather: Clear, Cool
 Interval (dd) : 15 (In Minutes)

PEAK HOURS	AM PERIOD 6:00AM-12:00PM	Start	End	Volume	PM PERIOD 12:00PM-7:00PM	Start	End	Volume
		11:00	12:00	3332		12:00	13:00	3263

PEDESTRIAN SCHOOL CHILDREN & U-TURN BREAKDOWN

Hour Ending	E. Lee Highway			Broadview Avenue			Winchester Street			Broadview Avenue		
	BIKES	PED.	U.T.	BIKES	PED.	U.T.	BIKES	PED.	U.T.	BIKES	PED.	U.T.
00:15												
00:30												
00:45												
01:00												
01:15												
01:30												
01:45												
02:00												
02:15												
02:30												
02:45												
03:00												
03:15												
03:30												
03:45												
04:00												
04:15												
04:30												
04:45												
05:00												
05:15												
05:30												
05:45												
06:00												
06:15	0	0	0	0	0	0	0	0	0	0	0	0
06:30	0	0	0	0	0	1	0	0	0	0	0	0
06:45	0	0	1	0	0	1	0	0	0	0	0	0
07:00	0	0	0	0	0	0	0	0	0	0	0	0
07:15	0	0	2	0	0	0	0	4	0	4	0	0
07:30	0	0	2	0	0	0	0	0	0	0	0	0
07:45	0	0	4	0	0	0	0	0	0	0	1	0
08:00	1	0	3	0	2	0	0	1	0	0	1	0
08:15	0	0	1	0	0	0	0	0	0	0	0	0
08:30	0	0	2	0	0	1	0	0	0	0	0	0
08:45	0	0	1	0	0	0	0	0	0	0	0	0
09:00	0	0	1	0	0	0	1	0	0	0	0	0
09:15	0	0	3	0	2	0	0	0	0	0	0	0
09:30	0	0	2	0	0	7	0	1	0	0	1	0
09:45	0	0	5	0	0	1	0	0	1	0	0	0
10:00	0	0	1	0	0	0	0	0	0	0	1	0
10:15	0	1	3	0	0	4	0	0	0	0	1	0
10:30	0	0	4	0	0	0	0	0	0	0	0	0
10:45	0	0	3	0	0	0	0	0	0	0	1	2
11:00	0	0	1	0	0	3	0	0	0	0	1	0
11:15	0	0	7	0	0	3	0	0	0	0	0	0
11:30	0	0	5	0	0	1	0	2	0	0	0	0
11:45	0	0	5	0	0	1	0	0	0	0	0	0
12:00	0	0	3	0	2	1	0	1	0	0	5	0
12:15	0	0	3	0	0	4	0	0	0	0	0	0
12:30	0	0	6	0	2	1	0	0	0	0	1	0
12:45	1	0	7	0	0	1	0	0	0	0	0	0
13:00	0	2	3	0	3	3	0	0	0	0	0	0
13:15	0	1	10	0	0	4	0	1	0	0	1	0
13:30	0	0	0	0	0	1	0	0	0	0	0	0
13:45	0	0	3	0	0	2	0	0	0	0	0	0
14:00	1	2	7	0	0	1	0	0	0	0	0	0
14:15	0	1	5	0	0	1	0	0	0	0	0	0
14:30	0	0	6	0	0	0	0	0	0	0	0	0
14:45	0	3	5	0	0	0	0	0	0	0	0	0
15:00	0	0	4	0	0	1	0	0	0	0	2	0
15:15	0	1	7	0	0	1	2	0	0	0	0	0
15:30	0	0	4	0	0	2	0	1	0	0	1	0
15:45	0	0	8	0	0	1	0	0	0	0	0	0
16:00	0	2	12	0	0	1	0	1	0	0	0	0
16:15	0	0	8	0	0	0	0	0	0	0	0	0
16:30	0	1	4	0	0	0	1	0	0	0	2	0
16:45	0	0	1	0	0	1	0	0	0	0	0	0
17:00	0	0	8	0	0	0	0	0	0	0	3	0
17:15	0	0	5	0	0	3	0	1	0	0	0	0
17:30	0	0	5	0	1	1	0	0	0	0	0	0
17:45	0	0	1	0	0	2	0	0	0	0	1	0
18:00	0	0	0	0	0	1	0	0	0	0	0	0
18:15	0	0	4	0	0	1	0	0	0	0	0	0
18:30	0	0	4	0	0	0	0	0	0	0	1	0
18:45	0	1	1	0	0	0	0	0	0	0	1	0
19:00	0	1	5	0	0	0	1	0	0	0	1	1
19:15												
19:30												
19:45												
20:00												
20:15												
20:30												
20:45												
21:00												
21:15												
21:30												
21:45												
22:00												
22:15												
22:30												
22:45												
23:00												
23:15												
23:30												
23:45												
00:00												
TOTAL	3	16	195	0	12	57	5	13	1	0	30	3
AM Peak Vol	0	0	20	0	2	6	0	3	0	0	5	0
PM Peak Vol	1	2	19	0	5	9	0	0	0	0	1	0

Request No.:
 Job No.:

Location: Broadview Avenue/E. Lee Highway @ Winchester Street
 Date: 10/25/2014 Saturday
 Recorder: JLR, BDD
 Interval (dd): 15
 (In Minutes)

County: Fauquier, VA
 Town: Warrenton
 Weather: Clear, Cool

PEAK HOURS	AM PERIOD	Start	End	Volume	PM PERIOD	Start	End	Volume
	6:00AM-12:00PM	11:00	12:00	3332	12:00PM-7:00PM	12:00	13:00	3263

Turning Movement Summary:

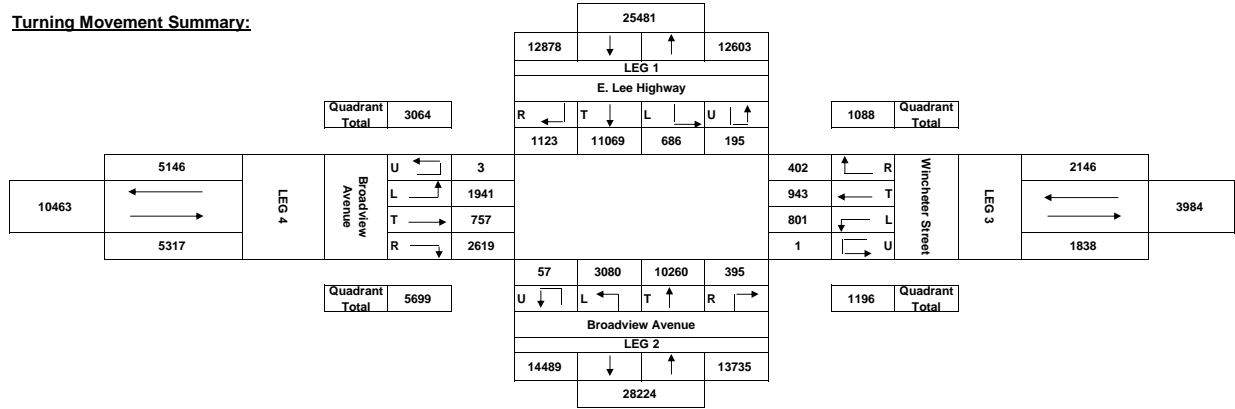

Comments:

AM Peak Hour : X:XX A.M. - X:XX A.M.

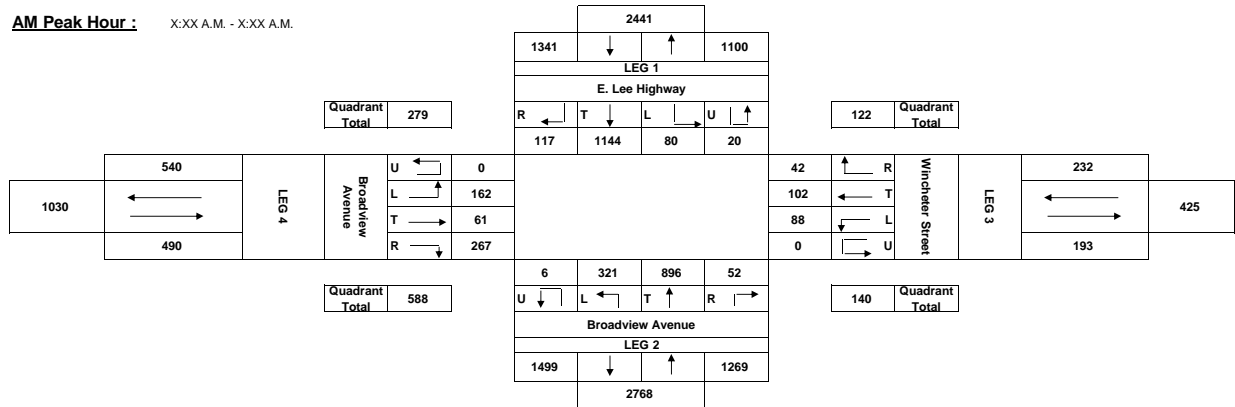

PM Peak Hour : X:XX P.M. - X:XX P.M.

